

**CardioChek<sup>®</sup>**  **P.A**

**Brand Analyzers  
Portable Whole Blood  
Test System User Guide**



**For Professional Use**

CLIAwaived<sup>TM</sup>.com

# TABLE OF CONTENTS

I. Introduction .....	4
II. Introduction to the CardioChek® PA Test System .....	5
CardioChek® PA device	
MEMo Chip®	
PTS Panels® test strips	
III. Setup .....	9
Installing Batteries	
CardioChek PA System Menus	
How to Turn Device Off	
Setting Language	
Setting Time	
Setting Date	
Setting Units	
Setting Sound	
Setup for Print	
IV. Checking the System .....	18
Check Strip	
Quality Control	
V. Quality Control Testing .....	20
Running a Control Test	
VI. Running a Test.....	22
Blood Testing	
Testing Supplies	
Quick Reference	
VII. Memory .....	26
Recalling Results	
Clearing Memory	
VIII. Care and Cleaning .....	28
Storage and Handling	
Cleaning Instructions	
IX. Troubleshooting .....	30
X. Interpreting Results.....	33
XI. CLIA Information .....	34
XII. Specifications.....	35
XIII. Contact Information.....	36
Help	
XIV. Warranty .....	37
XV. Explanation of Symbols .....	38
XVI. Index .....	39

## I. INTRODUCTION

The CardioChek® PA device from Polymer Technology Systems, Inc. (PTS, Inc.) is intended for *in vitro* diagnostic use, using whole blood samples. This point-of-care (POC) test system is designed for professional use. The CardioChek PA test system has an optional printer and the CardioChek Link® software solution to assist in data reporting.

The CardioChek PA device is fast, portable, and reliable. This device is a component of a test system that includes PTS Panels® test strips. The PTS Panels test strip box includes a MEMo Chip® that contains the assay calibration curve and other important information about the assay. PTS Panels test strips are sold separately, and are available as single and multiple analyte test strips.

This test system uses reflectance photometry technology. An enzymatic reaction on the test strip produces a color change that is detected by the device after whole blood is applied.

This User Guide includes all the information that you need to run POC assays using the CardioChek PA test system. Before you begin testing, please read this entire User Guide and the package inserts, which are included with the PTS Panels test strips.

Please remember to return the enclosed warranty card to PTS, Inc. to ensure that you receive product updates and other important information.

For questions or additional assistance with your CardioChek PA test system, please contact PTS, Inc. (Hours: 8:00 a.m. to 8:00 p.m. USA Eastern Time) using the following contact information:

**Polymer Technology Systems, Inc.**

7736 Zionsville Road  
Indianapolis, IN 46268 USA  
+1-317-870-5610 (Direct)  
+1-877-870-5610 (Toll-free inside the US)  
inforequest@cardiochek.com (E-mail)  
www.cardiochekpa.com

## II. INTRODUCTION TO THE CARDIOCHEK PA TEST SYSTEM

### **The CardioChek® PA Test System**

The CardioChek PA test system consists of three main parts. These include the device, PTS Panels® test strips, and a MEMo Chip®.

### **The CardioChek® PA Test System & Operating Principle**

The device employs light reflectance to measure an end-point enzymatic chemical reaction. The test strips are impregnated with enzymes which are specific for the analyte to be measured. Refer to the individual PTS Panels test strip package inserts for detailed information related to the enzymatic reaction. When blood is applied to the test strip, the ensuing sequence of chemical reactions results in a color change on the test strip which is measured by light reflectance. The intensity of this colorimetric substance is directly proportional to the amount of analyte in the blood. Using a stored standard calibration curve, the device calculates and displays the result on the screen.

## II. INTRODUCTION TO THE CARDIOCHEK PA TEST SYSTEM, continued

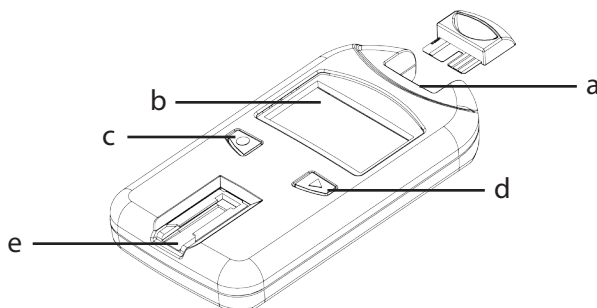

### **MEMo Chip Port (a)**

The MEMo Chip port is located at the top of the device.

### **Display (b)**

Display shows test results, messages, time, date, and stored results.

### **ENTER Button (c)**

Press this button to turn the device ON or to accept the current menu choice.

### **NEXT Button (d)**

Press this button to turn the device ON or to advance to the next menu option.

### **Test Strip Insert Opening (e)**

The test strip insert opening is positioned in the lower front of the device. The test strip is inserted here with the raised lines facing up.

## II. INTRODUCTION TO THE CARDIOCHEK PA TEST SYSTEM, continued

### The MEMo Chip®

Each package of PTS Panels® test strips contains a color-coded MEMo Chip. The color-coded MEMo Chip contains the settings for each test. The top of the MEMo Chip has a finger notch. The bottom has a label with the test name and lot number. Always make sure you insert the MEMo Chip into the port with the finger notch facing up.

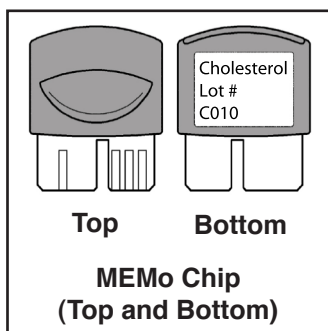

### What does the MEMo Chip do?

The MEMo Chip contains proper settings for the test strip lot you are using. The MEMo Chip:

- Reads the test strip expiration date
- Tells the device which test(s) to run
- Contains the calibration curve and the lot number for the specific test strip lot
- Controls test sequences and timing
- Establishes the measuring range for the test

### Guidelines for using the MEMo Chip

- The MEMo Chip must be in place to run a test.
- Use only the MEMo Chip that is included with each package of test strips. The lot number code on the test strip vial, MEMo Chip, and device display must match.
- If the expiration date in the MEMo Chip has expired, the device will display EXPIRED LOT.
- If your MEMo Chip is lost or missing, please call PTS, Inc. Customer Service for a replacement.

## II. INTRODUCTION TO THE CARDIOCHEK PA TEST SYSTEM, continued

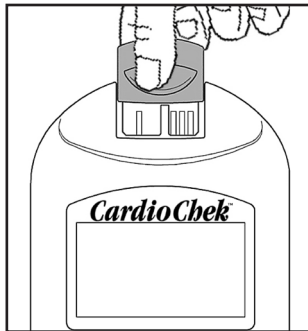

The MEMo Chip® port is located at the top center of the device. The MEMo Chip is inserted into this port with the finger notch facing up. Push firmly, but gently, until the MEMo Chip is fully inserted. **Important:** Be careful not to bend the connector.

### Test Strip

Test strips are designed for specific analytes. A test strip is inserted into the device, then blood is applied to the blood application window. As previously described, the ensuing chemical reaction produces a color change, which the device measures and compares to the calibration curve stored in the MEMo Chip. The device converts this color reading into a test result, displayed on the screen. Each PTS Panels® test strip box contains a package insert that provides instructions for use and information specific for each test. Please read the instructions completely before testing.

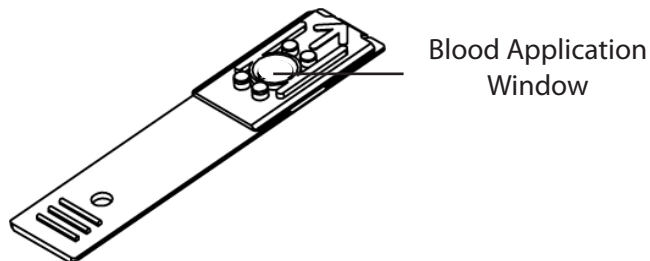

Example of a PTS Panels®  
test strip

### III. SETUP

#### **Battery Use and Replacement**

The CardioChek® PA device requires two (2) AAA 1.5 volt high quality alkaline batteries.

#### **When to Replace the Batteries**

The device will give you an indication on the display that the batteries need to be changed. When the display reads CHANGE BATTERY, no more tests can be run until the batteries are changed. Always replace the batteries with high quality alkaline batteries. It is recommended to keep a spare set of batteries on hand. To extend battery life, remove the test strip as soon as a result is displayed. The time/date and results stored in memory will not be erased when the batteries are changed.

#### **How to Install/Replace the Batteries:**

1. Open the battery door on the back of the CardioChek PA device by pressing and sliding it in the direction of the arrow (toward the MEMo Chip port).
2. Remove old batteries from the compartment and safely discard.
3. Insert the new batteries into the battery compartment with the positive (+) terminal facing to the left on the top battery, and to the right on the bottom battery as marked on the inside compartment.
4. Replace the battery door. To make sure the batteries were installed correctly, push either of the two buttons on the front of the device to turn the CardioChek PA device ON.

**WARNING!** Dispose of the old batteries properly.

### III. SETUP, continued

#### CardioChek® PA System Menus

This diagram provides a layout of the menus within the CardioChek PA device. Detailed information on the use of each menu follows in the Setup section of this User Guide.

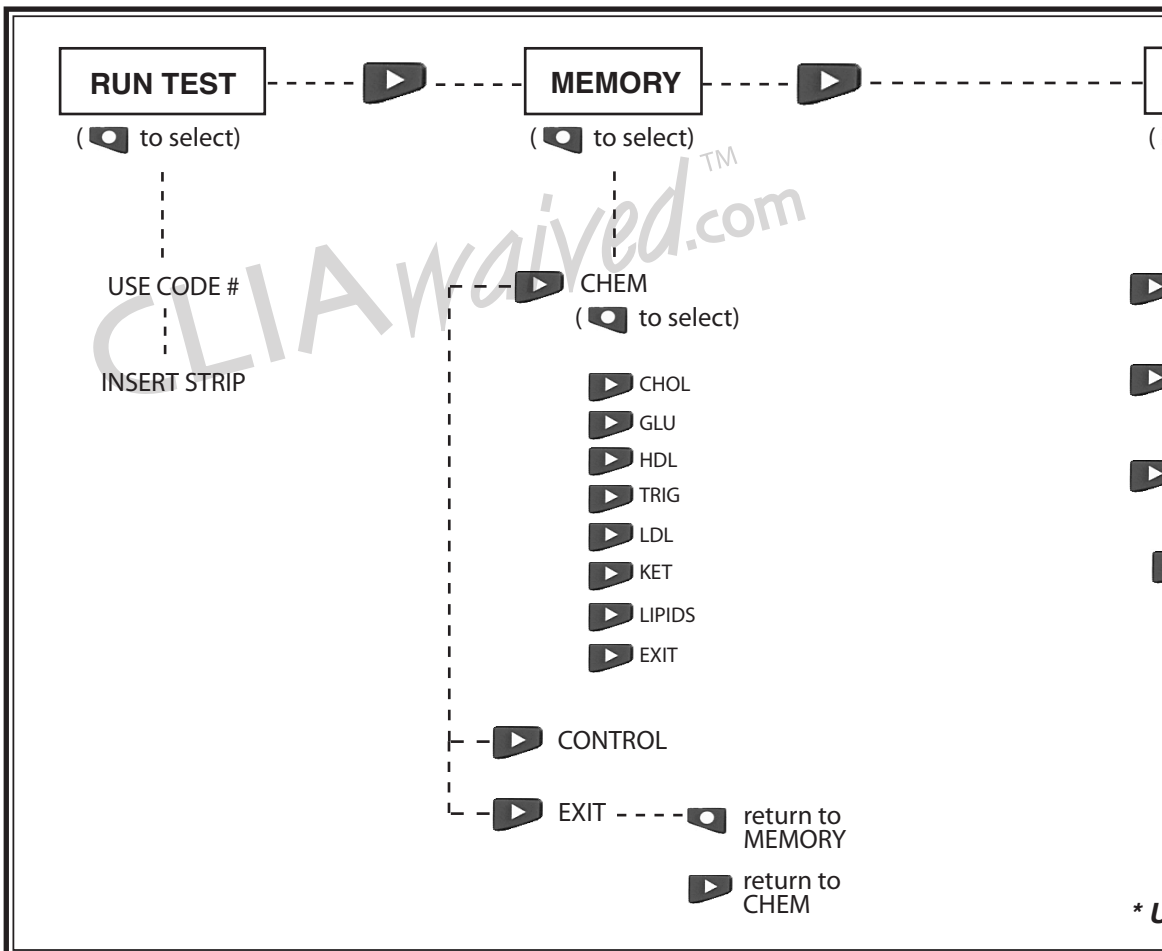

#### Buttons

**ENTER**  **Button:** Press this button to turn the device ON or to accept the current menu choice.



### III. SETUP, continued

**NEXT**  **Button:** Press this button to turn the device ON or to advance to the next menu option.

- Hold  and  down at the same time to shut off device from one of the main menus (RUN TEST, MEMORY, UTILITY, or USER SET).

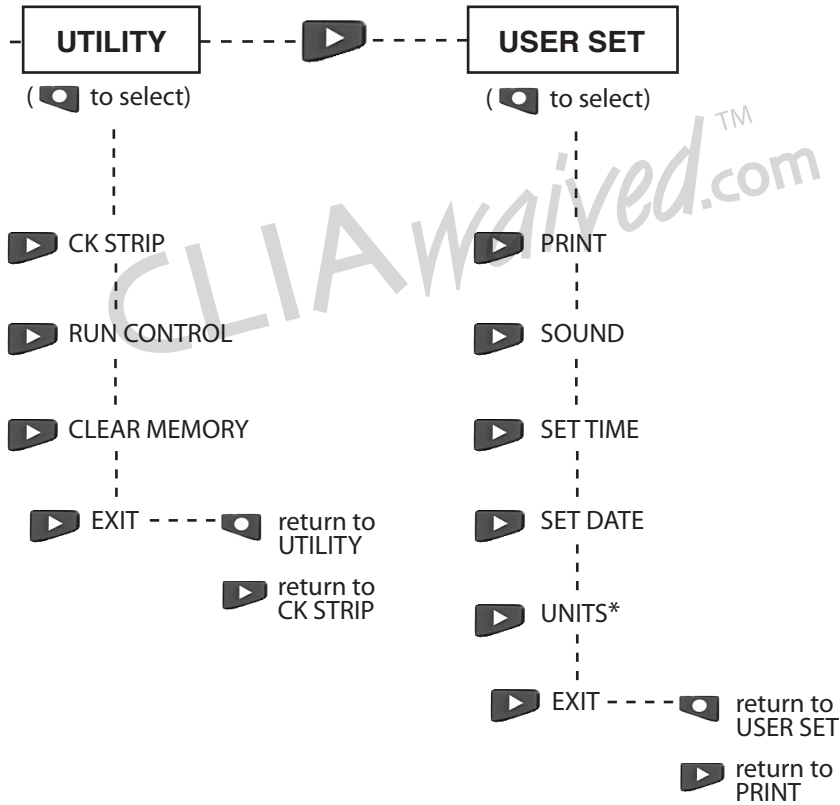

\* Units may be locked, and therefore UNITS will not appear.

### III. SETUP, continued

#### **How to Turn the Device OFF**

To turn device OFF press both buttons at the same time for three seconds at any of the following Main Menu headings: RUN TEST, MEMORY, UTILITY, or USER SET. After three minutes of idle time (without a test strip or check strip inserted) the device will perform a 10 second count down and turn OFF. To stop shutdown press either button. You can also remove the batteries to turn the device OFF.

The first time the device is turned on you will be required to set the language, date, and time.

#### **Setting Language**

The language menu consists of the following choices:  
English (ENGLISH), Spanish (ESPAÑOL),  
Italian (ITALIANO), German (DEUTSCH),  
French (FRANCAIS), Portuguese (PORTUGUESE), and  
Dutch (NEDERL).

#### **How to Set the Language:**

1. Turn the device ON by pressing either button (Enter or Next).
2. The display will read LANGUAGE. Press Enter.
3. ENGLISH will be displayed. Press Enter if English is desired.
4. For other languages press Next until the desired language is displayed, then press Enter. To set the time proceed to **How to Set the Time.**

### III. SETUP, continued

#### How to Reset the Language:

1. Allow the device to automatically turn OFF or remove the batteries and replace them.
2. Press and hold Enter  down for approximately 5 seconds, during the analyzer power-up stage until LANGUAGE is displayed.
3. Press Enter. Press Next to scroll through the language choices.
4. Press Enter to select the language that is displayed. SET TIME will be displayed.

#### How to Set the Time:

1. If the device is OFF, press either button to turn the device ON. Wait for the display to read either INSTALL MEMO CHIP (if a current MEMo Chip is not installed) or INSERT STRIP (if a current MEMo Chip is installed). Press Enter. The display will read RUN TEST.
2. Press Next until USER SET is displayed.
3. Press Enter. Press Next until SET TIME is displayed.
4. Press Enter and the clock format is displayed: 12/24 HR.
5. Press Next to alternately display the 12 hour AM/PM clock or the 24 hour clock. Press Enter to accept the displayed clock format. The display will read HOUR and the numerical hour. If 12 hour clock was chosen, AM/PM appears in the upper right hand corner of the display.
6. Press Next to increment the hour.
7. Press Enter to accept the displayed hour. The display will read MINUTE and the numerical minute.
8. Press Next to increment the minutes.

### III. SETUP, continued

#### **How to Set the Time, continued:**

9. Press Enter to accept the displayed minute. The display will read SET TIME. To set the date, proceed to **How to Set the Date** - Step 4.
10. To exit, press Next until EXIT is displayed. Press Enter.
11. Press Next to return the display to RUN TEST.

#### **How to Set the Date:**

1. If RUN TEST is displayed, go to Step 3. If the device is OFF, press either button to turn the device ON. Wait for the display to read INSTALL MEMO CHIP or INSERT STRIP.
2. Press Next. The display will read RUN TEST.
3. Press Next until USER SET is displayed. Press Enter.
4. Press Next until SET DATE is displayed.
5. Press Enter and the numerical month is displayed.
6. Press Next to increment the month.
7. Press Enter to accept the displayed month. The display will read DAY and the numerical day of the month.
8. Press Next to increment the day.
9. Press Enter to accept the displayed day. The display will read YEAR and the numerical year.
10. Press Next to increment the year.
11. Press Enter to accept the displayed year. The display will read SET DATE. To set the units, proceed to UNITS.
12. Press Next until EXIT is displayed. Press Enter.
13. Press Next to return the display to RUN TEST.

### III. SETUP, continued

#### How to Set the Units:

The CardioChek<sup>®</sup> PA device may be shipped with preset units.

#### NOTE:

- If the USER SET menu does not display "UNITS" the device is locked in preset units
- The units cannot be changed if the system has been locked
- To confirm current configuration of the device's units run a check strip in the RUN TEST mode and observe the units that are displayed

If your device's units have not been preset, follow the steps listed below to change your units to mg/dL, mmol/L, or g/L:

1. If RUN TEST is displayed, go to Step 3. If the device is OFF, press either button to turn the device ON. Wait for the display to read INSTALL MEMO CHIP or INSERT STRIP.
2. Press Enter. The display will read RUN TEST.
3. Press Next until USER SET is displayed.
4. Press Enter. The display will read PRINT.
5. Press Next until UNITS is displayed. If UNITS is not shown on the display, the units on this device have been locked and cannot be changed. If UNITS appears on the display screen, proceed to the next step.
6. Press Enter. The display will read mg/dL. If mmol/L or g/L is desired press Next until the desired unit appears on the display screen.
7. Press Enter to select the desired units. The display will then read UNITS.
8. Press Next until EXIT is displayed.
9. Press Enter to return to USER SET.
10. Press Next to return to RUN TEST.

### III. SETUP, continued

#### **How to Set the Sound:**

The CardioChek® PA device sound has been preset to BEEP ON. To turn the sound on or off please follow the steps listed below:

1. If RUN TEST is displayed, go to Step 3. If the device is OFF, press either button to turn the device ON. Wait for the display to read INSTALL MEMO CHIP or INSERT STRIP.
2. Press Next. The display will read RUN TEST.
3. Press Next until USER SET is displayed.
4. Press Enter, then Next until SOUND is displayed.
5. Press Enter. The display will read BEEP ON or BEEP OFF.
6. Press Next to select either BEEP OFF or BEEP ON.
7. Press Enter to accept the sound choice displayed.
8. Press Next until EXIT is displayed.
9. Press Enter to return display to USER SET.
10. Press Next to return to RUN TEST.

#### **Introduction to the CardioChek PA and Printer System**

The CardioChek PA device (with software version 2.20 and higher) supports printing in two formats, label or paper, on the CardioChek PA Thermal Printer or Portable Printer. To verify CardioChek PA test system software, turn the device ON by pressing either button. The software version will appear on the display.

#### **How to Set Up the CardioChek PA for Printing**

For complete details, refer to each printer's User Guide.

### III. SETUP, continued

#### **How to Print Results From Memory:**

(Up to 30 test results per chemistry; up to 10 Control results)

1. Turn the CardioChek® PA device ON by pressing either button.
2. Press Enter until RUN TEST is displayed.
3. From the RUN TEST menu press Next.
4. MEMORY will be displayed. Press Enter.
5. Press Enter to select CHEM.
6. Press Next to select the type of test, LIPIDS for example.
7. Press Next to select the date/time of the test result you want to print.
8. Press Enter to print the selected number of copies of results.
9. Control results can be printed by selecting CONTROL instead of CHEM and then selecting the type of result as stated above.

## IV. CHECKING THE SYSTEM

### Device Check Strip

A Quality Control of the device operation can be performed using the gray check strip. The check strip (included in the device carrying case) verifies that the CardioChek® PA device's electronic and optical systems are functioning properly. Each gray check strip is calibrated to read a specific reflectance. To perform this verification, insert the check strip into the device. The device will read the reflectance of the gray check strip and indicate if the reading is within the acceptable range. When the check strip is not in use, please store it in the device carrying case. It is recommended that the check strip verification be performed:

- Daily
- If the device has been dropped
- When a result is not consistent with prior results

### How to Use the Device Check Strip:

1. Turn the device ON by pressing either button.
2. When INSTALL MEMO CHIP or RUN TEST is displayed, press Next until UTILITY is displayed. Press Enter.
3. Press Enter when CK STRIP is displayed.
4. Hold the check strip at base and insert the check strip, ribbed side up, into the test strip insert opening when INSERT STRIP is displayed.
5. The device should display PASSED. (If the display reads FAILED, see the NOTE at the end of this section.) Remove the check strip and store it in the device carrying case.
6. Press Next until EXIT is displayed. Press Enter.
7. Press Next until RUN TEST is displayed.
8. Press Enter. The device is ready to run tests.

## IV. CHECKING THE SYSTEM, continued

### How to Use the Device Check Strip, continued:

**Note:** If the device displays FAILED:

1. Clean the CardioChek<sup>®</sup> PA device test strip insert opening (where the check strip is inserted into the device). See the Care and Cleaning section (page 29 of this User Guide).
2. Inspect the check strip to make sure it is not dirty or damaged. Use the spare check strip and repeat.
3. See the Troubleshooting section.

### Quality Control

Controls (also known as “Quality Control materials”) are solutions for which an expected analyte concentration range has been established. Controls are tested to check the performance of your test system: CardioChek PA device, MEMo Chip<sup>®</sup>, and test strips. Use Quality Control materials provided by PTS, Inc. or commercially available Quality Control materials. Currently PTS, Inc. has available:

PTS Panels<sup>®</sup> Multi-Chemistry Controls                      REF 721

PTS Panels<sup>®</sup> HDL Controls    REF 722

Refer to control package insert for control specifications.

Healthcare professionals should follow their facility’s guidelines and policies regarding quality assurance and the use of Quality Control materials. Quality Control materials should be run whenever a new lot of PTS Panels<sup>®</sup> test strips are received.

**IMPORTANT: Check the expiration date printed on the control bottles. Do not use control solutions that have expired.**

For performing a Quality Control test, see Section V. QUALITY CONTROL TESTING.

To perform a control test you need:

- CardioChek PA device
- PTS Panels<sup>®</sup> test strips
- Quality Control materials
- Quality Control Instructions
- Quality Control Range Insert

## V. QUALITY CONTROL TESTING

### How To Run a Quality Control Test:

1. Install the correct MEMo Chip® for the lot of test strips that you are using.
2. Press either button to turn the device ON.
3. Press Next until the display reads UTILITY. Press Enter.
4. Press Next until RUN CONTROL scrolls across the display. Press Enter.
5. Insert the test strip into the device. The CardioChek® PA device will display APPLY SAMPLE. This indicates the system is ready for a sample (control) to be applied. Immediately replace the vial cap, making sure the test strip vial is closed tightly.
6. Remove cap from the Quality Control material and turn bottle upside down.  
CONTROL MUST BE APPLIED TO TEST STRIP  
WITHIN 10 SECONDS OF REMOVING THE TEST  
STRIP FROM THE VIAL.
7. Hold bottle directly over and perpendicular to the blood application window on the test strip.
8. Squeeze bottle, so a small drop of control solution is formed.
9. Allow the drop of control solution to fall onto the application window of the test strip. Do not allow the tip of the bottle to touch the test strip.
10. Replace cap on the Quality Control material.

## V. QUALITY CONTROL TESTING, continued

### How To Run a Quality Control Test, continued:

11. During testing CONTROL is displayed. Results will be displayed within about one to two minutes.
12. Compare control results to the values on the Quality Control Range Insert included with control materials.
13. The control result(s) will also be stored in the device's memory.
14. To exit the control testing menu press Enter twice. RUN CONTROL will be displayed.
15. Press Next until EXIT is displayed. Press Enter.
16. Press Next until RUN TEST is displayed.

### If Quality Control Results are Not in Range

1. Ensure test strip insert opening area is clean.
2. Make sure neither the test strips nor the controls are past the expiration date printed on the label.
3. Make sure the MEMo Chip<sup>®</sup> matches the test strip lot.
4. Repeat the test again using fresh materials.
5. Call Customer Service for assistance.

## VI. RUNNING A TEST

### **Blood Testing**

A test strip package insert is included with each box of test strips. Please read the test strip package insert along with this section of the User Guide completely and carefully before testing.

### **Testing Supplies**

To perform a blood test you need:

- CardioChek® PA device
- PTS Panels® test strips
- Lot-specific MEMo Chip®
- Sterile lancet
- Capillary blood collector or pipet
- Gauze or cotton balls
- Alcohol wipe (optional)

This device requires whole blood for testing. Do not operate the device in direct light. Reference the Care and Cleaning section for more information.

### **Helpful Hints on Getting a Good Drop of Blood**

1. Warm the fingers to increase blood flow.
2. Let the arm hang down at the person's side briefly to allow blood flow to the finger tips.
3. Instruct the patient to wash hands in warm, soapy water. Rinse well and dry completely. If an alcohol wipe is used, let the finger air dry before testing.

## VI. RUNNING A TEST, continued

### How to Obtain a Blood Sample:

To perform a fingerstick:

1. Clean the finger. Be sure the finger is completely dry.
2. Use a new sterile, disposable lancet to puncture the skin.
3. Stick the finger on the side of the fingertip, instead of the center. See picture below:

CORRECT WAY TO  
STICK THE FINGER

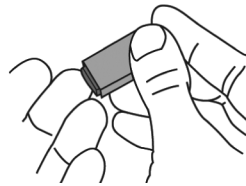

4. To get a drop of blood, gently apply pressure to the finger starting at the end of the finger closest to the hand and moving towards the tip. Wipe away the first drop of blood with gauze and use the second blood drop for testing. The blood drop should be hanging down from the finger to make it easier to collect the sample with a capillary pipet or plastic blood collector.
5. Follow the specific instructions found in the test strip package insert for each test for sample application and volume ranges. Use of capillary pipet or plastic blood collector ensures a sufficient volume of blood has been applied to the test strip.
6. Make sure the test strip is inserted all the way into the test strip insert opening.
7. Use the test strip and lancet one time only. Dispose of properly.

**Precaution: Handle and dispose of all materials coming in contact with blood according to universal precautions and guidelines.**

## VI. RUNNING A TEST, continued

### How to Run a Test:

1. Insert correct MEMo Chip® for the lot of strips in use.
2. Insert MEMo Chip with finger notch (top) side up, lot number code facing down.
3. Turn CardioChek® PA device ON by pressing either button.
4. When INSERT STRIP is displayed, insert the test strip into the device as far as it will go.
5. Obtain a blood drop following the correct technique.
6. When APPLY SAMPLE is displayed, apply blood to the test strip. Refer to each specific test strip package insert for sample volume and sample application instructions.
7. Within one to two minutes, the results will be displayed.
8. Remove test strip and discard.
9. The device automatically shuts down after three minutes of idle time with no test strip inserted.

**IMPORTANT:** Do not leave a used test strip or check strip in the device test strip opening. This prevents the device from automatically shutting down and shortens battery life.

## VI. RUNNING A TEST, continued

### Quick Reference Testing Guide

1. Insert MEMo Chip<sup>®</sup> with lot number that matches test strip vial lot number. Press either button to turn the CardioChek<sup>®</sup> PA device ON. Device will display lot code.

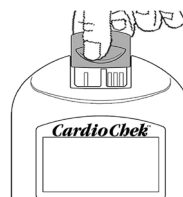

2. When INSERT STRIP is displayed, hold by the raised lines and insert test strip into the device as far as it will go.

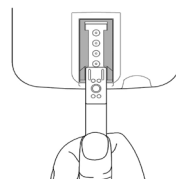

3. When APPLY SAMPLE is displayed, apply whole blood\* sample with a capillary pipet to blood application window.



4. Within two minutes the result will appear on the display. Remove and discard strip. Do not add more blood to a test strip that has been used.

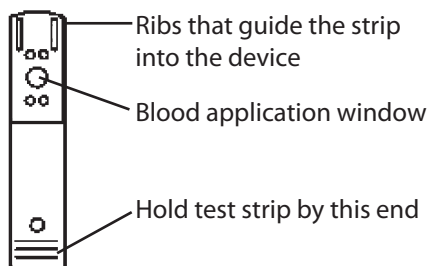

Example of a PTS Panels<sup>®</sup> test strip

\* Refer to each specific test strip package insert for sample volume and sample application instructions.

## VII. MEMORY

Test results are automatically stored in the device's memory. A CardioChek® PA device can store up to 30 results of each chemistry and at least 10 results of each control test. The device allows review of the results in order from the most recent to the oldest. Each result is displayed with time and date. Results stored in memory are not deleted when the batteries are changed.

### **How to Review Results Stored in Memory:**

1. Press either button to turn the device ON. If the display reads INSTALL MEMO CHIP go to Step 2. If the display reads INSERT STRIP press Enter.
2. Press Next until MEMORY is displayed.
3. Press Enter. CHEM is displayed.
4. Press Enter, then Next to select the desired chemistry. (Note: Until the chemistry has been run at least once, the test name is not displayed.)
5. Press Enter to view the test result including time and date.
  - a. To recall Control results, press Next until EXIT is displayed. Press Enter. Press Next until CONTROL is displayed.
  - b. Press Enter when the desired Control test is displayed.
  - c. For example, to review Lipid Panel results, from the CHEM display, press Next until LIPIDS is displayed, then Enter. The time and date will be displayed. Press Enter when the desired test time and date is displayed. Press Next to scroll through results.
6. To exit, press Next until the display reads EXIT, then press Enter. Repeat this step until you return to RUN TEST.

## VII. MEMORY, continued

### How to Clear Results Stored in Memory:

1. Press either button to turn the device ON. Wait for the display to read either INSTALL MEMO CHIP or INSERT STRIP.
2. Press Enter, then press Next until UTILITY is displayed. Press Enter.
3. Press Next until CLEAR MEMORY is displayed. Press Enter.
4. Press Next until the display reads CLR YES. Press Enter. The display will read ERASE, CLEARED, and then CLEAR MEMORY.
5. To exit, press Next until the display reads EXIT, then press Enter. Press Next until you return to RUN TEST.

CLIAwaived.com<sup>TM</sup>

## VIII. CARE AND CLEANING

### Storage and Handling

- Handle the CardioChek® PA device with care; do not drop.
- Do not store or operate the device in direct light, such as sunlight, spotlight, under a lamp, or by a window.
- Do not expose the device or any of the supplies or accessories to high humidity, extreme heat, cold, dust, or dirt. The device may be stored at a temperature of 68-80° F (20-27°C) and 20-80% Relative Humidity (RH).  
**Do not freeze.** If storage temperature is below 68° F (20°C) allow the device to warm up to room temperature 68° F (20°C) before using. If the device has been stored under excessive conditions, allow at least 30 minutes at room temperature for the device to equilibrate to these temperatures.
- Blood testing should be conducted in "controlled room temperature" conditions.

Optimal Operating Conditions
20 - 27 °C
68 - 80 °F

- Do not scratch or damage the surface of the check strip. Please read the test strip package insert for storage and handling information that applies to each test strip.

## VIII. CARE AND CLEANING, continued

### Cleaning Instructions

1. Locate the optical glass and the test strip insert opening.
2. Open an alcohol wipe/prep pad.
3. Fold the wipe and carefully wipe the optical glass and test strip guides clean. If the area is especially dirty, this may require additional wipes.
4. Immediately dry the optical glass completely with gauze. Make sure the glass is clean, dry, and completely free from any fingerprints, dust, or smudges. The glass must look clean when held at different angles.

If the exterior of the device needs cleaning, wipe with a damp (not wet) alcohol wipe or dampen cloth with water or medical grade disinfectant (such as Sporocidin®) and wipe surfaces and the display area very carefully. Be careful not to get the test strip insert opening (where the test strip is inserted) wet. **Do not use bleach, window cleaner, or hydrogen peroxide.**

## IX. TROUBLESHOOTING

MESSAGE or ISSUE	PROBABLE CAUSE	WHAT TO DO
Desired language is not displayed.	Language has been set incorrectly.	Turn device OFF. See Section III., Setup - How to Reset the Language.
The wrong date and/or time is displayed.	Date and time have not been set correctly.	See Section III., Setup to set the correct date and time.
FAILED is displayed during a check strip test.	Device needs to be cleaned.  Check strip is dirty or damaged.	Wipe the test strip insert opening with a clean, damp, and lint-free cloth.  Use spare check strip. If check strip still fails, call Customer Service.
TOO MUCH LIGHT	Test is being performed in direct light or outside.	Test inside, away from windows, and away from direct lamp light.
MEMO ERR	MEMo Chip® is defective.	Use another MEMo Chip from the same lot.
TEST ERR	Insufficient sample has been added to test strip.	Test again with a new test strip and make sure the correct volume of sample is used.
LANGUAGE	Device is new or language option has not been set.	Follow User Guide instructions to set language.
TEST NOT ALLOWED	Test selected by MEMo Chip installed cannot be run on your device.	Check MEMo Chip and make sure that the correct MEMo Chip is inserted. Call Customer Service.
LOW TEMP	Device is below acceptable operating temperature.	Move to warmer environment and test after device reaches proper temperature.
HI TEMP	Device is above acceptable operating temperature.	Move to acceptable environment and test after device reaches proper temperature.

## IX. TROUBLESHOOTING, continued

MESSAGE or ISSUE	PROBABLE CAUSE	WHAT TO DO
INSTALL MEMO CHIP	MEMo Chip® is not properly inserted or is defective.	Insert same or new MEMo Chip properly.
EXPIRED LOT	Test strips are expired, wrong MEMo Chip is inserted, or date is not set properly.	Check test strip expiration date and make sure correct MEMo Chip is inserted. Check date setting – follow User Guide instructions.
CHANGE BATTERY	Batteries need to be replaced.	Replace both batteries with new high quality AAA batteries. (The device will not run tests until batteries are replaced.)
TEST ABORTED	Test strip was not properly inserted or was removed before test was complete.	Test again with fresh test strip.
PRINT ERROR	Print function has been interrupted.	Print result in MEMORY or test again.
Results will not print.	<p>Communication Cable was improperly connected.</p> <p>Printer cover is not closed properly. (Printer indicator light is red.)</p> <p>Labels/paper were not loaded in the printer.</p>	<p>Check all connections. Reprint test results stored in memory.</p> <p>Close printer cover correctly, ensuring that the Printer indicator light is green. Reprint test results stored in memory.</p> <p>See CardioChek PA &amp; Printer System Setup/Operating System Instruction Sheet packaged with thermal printer.</p>

## IX. TROUBLESHOOTING, continued

MESSAGE or ISSUE	PROBABLE CAUSE	WHAT TO DO
Results are not as expected.	Test strips improperly stored.	Repeat test, using a different vial of test strips. Run controls, confirm that results are in range.
	Batteries are defective.	Change batteries.
	The device was improperly stored.	Make sure device was not exposed to high or low temperatures or humidity and repeat test.
	Test strip insert opening is dirty.	Clean the test strip insert opening.
	MEMo Chip® and test strips are not the same lot number.	Use MEMo Chip and test strips with the same lot number.

## X. INTERPRETING RESULTS

All test results must be assessed by a qualified medical professional. Depending on the analyte being assessed, high or low results may have medical consequences. If the result reads > (greater than) or < (less than) or results are not as expected, always repeat the test correctly with a new unused test strip. If a test result is displayed that is not expected, consult the following table.

MESSAGE or ISSUE	PROBABLE CAUSE	WHAT TO DO
A displayed result reads < (less than) a value.	Result is below the measuring range of the test.	If you or your patient have symptoms call a healthcare professional immediately. Repeat the test. Run controls and confirm that controls are in range.
A displayed result reads > (greater than) a value.	Result is above the measuring range of the test.	If you or your patient have symptoms call a healthcare professional immediately. Run test again. Run controls and confirm that controls are in range.
Display reads " _ _ _ " or N/A.	Result is not available due to a missing value from a calculation, or a value is outside the measuring range.	Run test again. Run controls and confirm that controls are in range.
TRIGS TOO HIGH LDL N/A	Lipid Panel triglycerides test result was 400 mg/dL (4.52 mmol/L) or greater.	No action needed. LDL will not be calculated on samples with triglycerides of 400 mg/dL (4.52 mmol/L) or greater.

## XI. CLIA INFORMATION

### **General CLIA Information (US Only)**

*(Please read before testing)*

1. CLIA-waived. Each laboratory or testing site using the PTS Panels® test strips MUST have a CLIA Certificate of Waiver (or other CLIA operating license) before testing. To obtain a Certificate of Waiver or any other type of laboratory license, call your state health department or PTS, Inc. at +1-877-870-5610 (Toll-free) or +1-317-870-5610 for an application (form CMS 116).
2. Before you start testing, carefully read all instructions, including Quality Control. Failure to follow instructions, including Quality Control instructions, will result in high complexity rating and subject the facility to all applicable CLIA requirements for high complexity testing. For complete information including performance, please refer to the product specific package insert and User Guide.
3. CLIA-waived for whole blood (fingerstick and venous EDTA or heparin) testing only.

## XII. SPECIFICATIONS

### CardioChek® PA Device

Calibration Curve: Input from MEMo Chip® per test strip lot

Battery: 2 AAA 1.5 volt alkaline

The device Storage Conditions and Operating Range are as follows:

Storage Conditions	Optimal Operating Conditions
18 - 35 °C 64 - 95 °F	20 - 27 °C 68 - 80 °F

Humidity Range: Between 20 and 80% RH

Dimensions:

Width: 3.0 in (7.62 cm)  
Length: 5.5 in (13.97 cm)  
Height: 1.0 in (2.54 cm)  
Weight: (without batteries): 4-6 oz. (113.4 - 170.1 g)

### PTS Panels® test strips

Please read the instructions (package insert) included with the test strips for information specific to each chemistry.

### Optional CardioChek PA Thermal Printer/Power Supply

For complete details, refer to each printer's User Guide.

### XIII. CONTACT INFORMATION

#### **Help**

For assistance with the CardioChek® PA test system, please contact:

#### **Polymer Technology Systems, Inc.**

+1-877-870-5610 (Toll-free inside USA)

+1-317-870-5610 (Direct)

+1-317-870-5608 (Fax)

E-mail: [inforequest@cardiochek.com](mailto:inforequest@cardiochek.com)

Web site: [www.cardiochekpa.com](http://www.cardiochekpa.com)

CLIAwaived.com<sup>TM</sup>

## XIV. WARRANTY

### **CardioChek® PA Device Limited One Year Warranty**

PTS, Inc. warrants to the original purchaser only, that the device shall be free of any defects in materials or workmanship for a period of one year from the date of original purchase. Activation of this warranty shall be conditioned upon completion and return of the warranty registration card to PTS, Inc. If the equipment becomes inoperative during this time, PTS, Inc. will replace the equipment with equivalent equipment, at its option, at no cost to the purchaser. The warranty becomes void if the equipment is modified, improperly installed or operation not in accordance with the User Guide, damaged by accident, or neglect, or if any parts are improperly installed or replaced by the user.

**Note: Removing or loosening screws from the back of the device voids all warranties. There are no user serviceable parts inside the case.**

## XV. EXPLANATION OF SYMBOLS

### CardioChek® PA Test System Symbols



Consult Instructions for Use



Temperature Limitation

**IVD**

In vitro diagnostic medical device

**SN**

Serial Number



Manufacturer

**REF**

Catalog Number

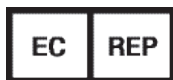

Authorized representative in the European Community



This product fulfills the requirements of the European Directive 98/79 EC for in vitro diagnostic medical devices.

## XVI. INDEX

Device Introduction.....	4-6
Battery Installation.....	9
Blood Testing .....	22-24
CLIA Information .....	34
Check Strip.....	18-19
Cleaning.....	28-29
Contact Information.....	36
Date (Setting).....	14
Help .....	36
Interpreting Results.....	33
Language (Setting) .....	12-13
MEMo Chip .....	7-8
Memory.....	26-27
Quick Reference (For Running a Test) .....	25
Quality Control.....	19-21
Shut Down .....	12
Sound (Setting) .....	16
Specifications.....	35
Symbols .....	38
Testing (Blood) .....	22-24
Time (Setting) .....	13-14
Troubleshooting Table.....	30-32
Units (Setting).....	15
Warranty .....	37

The CardioChek<sup>®</sup>, CardioChek<sup>®</sup> PA and associated test strips are covered by one or more of the following patents: U.S. Patent Nos. 7,435,577, 7,625,721, 7,087,397, 7,214,504, 7,374,719, 7,494,818, 5,597,532, and D534444; Australian Patent No. 2002364609; Eurasian Patent No. 010414; Mexican Patent No. 267323; South African Patent Nos. 2004/4929 and 2006/06561; EP Patent No. 0750739 (DE, FR, GB, IT).

CLIAwaived.com<sup>TM</sup>

CE 0197

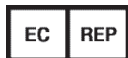

Authorized European Representative  
MDSS  
Schiffgraben 41  
30175 Hannover  
Germany

© Copyright 2010 Polymer Technology Systems, Inc.

PS-002461E Rev. 3 11/10

Distributed by: **CLIAwaived.com<sup>TM</sup>**  
San Diego, CA 92121  
tel 858-481-5031  
toll free 888-882-7739  
www.cliawaived.com