

Instruction Manual

C401/301/201/102/101

Portable Colorimeter



OAKTON[®]

EUTECH
INSTRUMENTS

Technology Made Easy...

ISO 9001
CERTIFIED

68X357704 Rev. 0 08/04

Distributed by: **CLIAwaived.com**[™]
San Diego, CA 92121
tel 858-481-5031
toll free 888-882-7739
www.cliawaived.com



Preface

This manual functions in two ways: first as a step by step guide to help you operate the waterproof C401/301/201/102/101 Colorimeter; second, it serves as a handy reference guide.

It contains basic instructions that you must follow during the operation, care and maintenance of the instrument. The safety protection provided by this equipment may be impaired if it is used in a manner not described in this manual. It is recommended that all operators should read this manual prior to working with this instrument.

Eutech Instruments/ Oakton Instruments cannot accept any responsibility for damage or malfunction to the meter caused by improper use of the instrument.

The information presented in this manual is subject to change without notice as improvements are made, and does not represent a commitment on the part of Eutech Instruments Pte Ltd/ Oakton Instruments.

Note: Eutech Instruments Pte Ltd/ Oakton Instruments reserves the right to make improvements in design, construction, and appearance of our products without notice.

Copyright © 2004 All rights reserved.

Eutech Instruments Pte Ltd

Oakton Instruments

Rev. 0 08/04

TABLE OF CONTENTS

1	INTRODUCTION	1
1.1	UNPACKING C401/301/201/102/101 COLORIMETER AND ACCESSORIES	2
1.2	DISPLAY	3
1.3	KEYS AND FUNCTIONS.....	4
1.4	BATTERY INSTALLATION	5
2	MEASUREMENT	6
2.1	GENERAL INFORMATION.....	6
2.2	PREPARATION OF SAMPLE VIAL	7
2.3	MEASUREMENT PROCEDURE	7
2.4	CHLORINE, FREE & TOTAL (0 – 6PPM CL ₂)	9
2.4.1	<i>Sample Collection</i>	11
2.4.2	<i>Sample Measurement</i>	11
2.4.3	<i>Interferences</i>	12
2.4.4	<i>Correcting for dilution</i>	13
2.4.5	<i>Accuracy Check / User Calibration</i>	13
2.4.6	<i>Chemistry</i>	14
2.5	CYANURIC ACID (5-90 PPM)	15
2.5.1	<i>Sample Collection</i>	17
2.5.2	<i>Sample Measurement</i>	17
2.5.3	<i>Interferences</i>	17
2.5.4	<i>Accuracy Check / User Calibration</i>	17
2.5.5	<i>Chemistry</i>	18
2.6	PH (5.9-8.2 PH UNITS)	19
2.6.1	<i>Sample Collection</i>	21
2.6.2	<i>Sample Measurement</i>	21
2.6.3	<i>Interferences</i>	21
2.6.4	<i>Accuracy Check / User Calibration</i>	21
2.6.5	<i>Chemistry</i>	22
3	CALIBRATION.....	23
3.1	CALIBRATION PROCEDURE	23
3.2	CHLORINE, FREE & TOTAL	24
3.3	CYANURIC ACID	27
3.4	PH.....	30
3.5	RESTORING FACTORY CALIBRATION	33
4	TROUBLESHOOTING GUIDE	35
5	ROUTINE MAINTENANCE	36
5.1	VIALS – HANDLING, CLEANING AND CARE	36
6	ACCESSORIES	37
7	SPECIFICATIONS	38
8	WARRANTY	39
9	RETURN OF ITEMS	39

1 INTRODUCTION

Thank you for selecting the waterproof portable C401/301/201/102/101 Colorimeter. Depending on the model selected, the C401/301/201/102/101 Colorimeter allows you to measure up to four parameters - namely the pH, Cyanuric acid, Free Chlorine and Total Chlorine of an aqueous sample in the field. You have one of the following models:

- C101: pH measurement
- C102: Cyanuric Acid measurement
- C201: Free Chlorine and Total Chlorine measurement
- C301: Free Chlorine, Total Chlorine and pH measurement
- C401: Free Chlorine, Total Chlorine, Cyanuric Acid and pH measurement

CLIAwaivedTM.com

1.1 Unpacking C401/301/201/102/101 Colorimeter and Accessories

The table below indicates the items that you should find in your Colorimeter shipment.

Item	Quantity
1. Field Portable C401/301/202/102/101 Colorimeter with 4 “AAA” batteries	1
2. Instruction Manual	1
3. Instrument Carrying Case	1
4. Empty Vial	4
5. pH Indicator (Phenol Red) Reagent Kit (Only for C101, C301, C401)	1
6. Cyanuric Acid Reagent Kit (Only for C102, C401)	1
7. Free Chlorine DPD Reagent Kit (Only for C201, C301, C401)	1
8. Total Chlorine DPD reagent Kit (Only for C201, C301, C401)	1

Remove C401/301/201/102/101 Colorimeter from the packing carton. Carefully inspect all items to ensure that no visible damage has occurred during shipment. If the items you received do not match your order, please contact your nearest distributor immediately.

WARNING: Extra care should be taken when unpacking, opening, and handling the sample vials. Surface scratches or finger smudges on the vial surface may cause measurement errors. Handle these items by their caps only.

Batteries provided with the meter package are to be installed prior to use. See Section 1.4 Battery Installation on page 5.

In the next page, Figure 1 depicts the meter. The three main components of the instrument are the sample well, the display, and the keypad. The following sections will describe the functionality of the display and the keypad. The proper use of the instrument will be discussed in later sections.



Figure 1: Parts of C401/301/201/102/101 Colorimeter

1.2 Display

All the LCD segments and annunciators that can appear on the display are shown in Figure 2. The display is used for reporting the colorimeter reading, communicate error messages and provide guidance for the operation of the instrument.

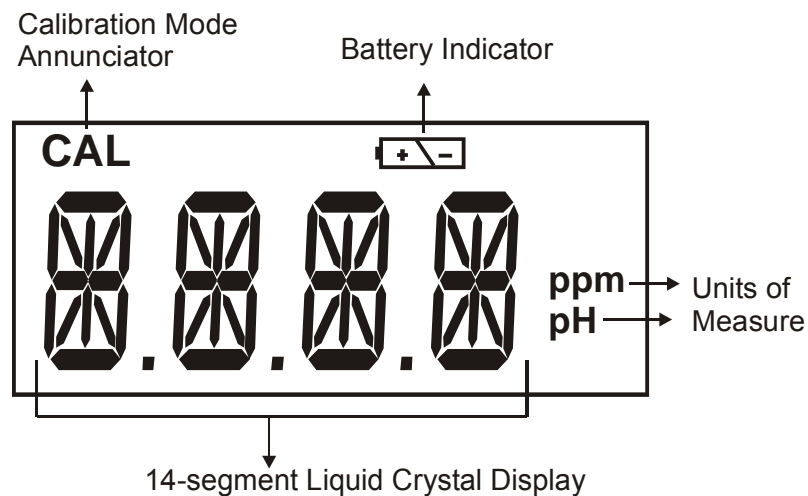

Figure 2: Customized LCD when switched on

1.3 Keys and Functions

The keypad has four keys: ON/OFF, MODE, ZERO and READ/ENTER.

Keys	Functions
ON/OFF	<ul style="list-style-type: none">- Powers on and shuts off the meter. With the auto switch-off feature the meter automatically shuts off 10 minutes after last key press.
MODE	<ul style="list-style-type: none">- Selects the test to be performed.- Selects the calibration point in an incremental circular manner during calibration.
ZERO	<ul style="list-style-type: none">- Blanks the instrument (sets the meter to zero) before chemical reagent is added.- Initiates the calibration mode when used with the ON/OFF key.- Aborts the calibration process without saving.- Exits the calibration mode.
READ / ENTER	<ul style="list-style-type: none">- Initiates the measurement of the sample after the chemical reagent has been added.- Confirms the test selection.

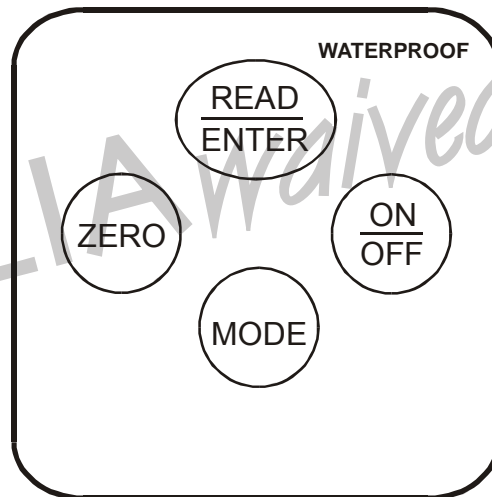

Figure 3: C401/301/201/102/101 Keypad

1.4 **Battery Installation**

Four AAA-sized batteries are included in your meter's packaging:

1. Use a Philips screwdriver to remove the two screws holding the battery cover. See Figure 4 : Battery Installation.
2. Remove the battery cover.
3. Insert the batteries. Follow the diagram inside the cover for correct polarity.
4. Replace the battery cover onto its original position using the two screws removed earlier.
5. The meter is now ready to operate.

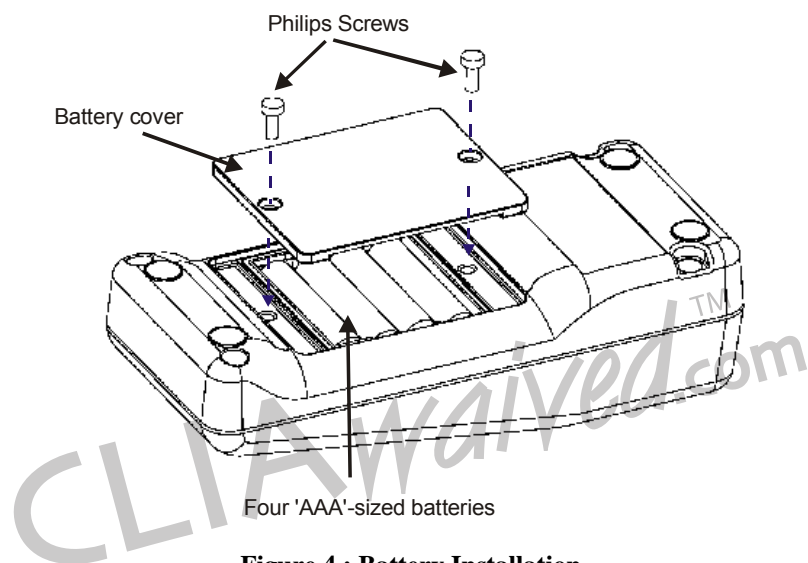

Figure 4 : Battery Installation

NOTE: Dispose used batteries in accordance with your local regulations.

2 MEASUREMENT

2.1 General Information

The waterproof C401/301/202/102/101 Colorimeter allows you to measure up to four parameters - namely the pH, Cyanuric acid, Free Chlorine and Total Chlorine of a sample and reports the results in appropriate units (ppm or pH). Each specific measurement has its own range as listed in the specifications.

The meter will go through a power sequence as shown below.

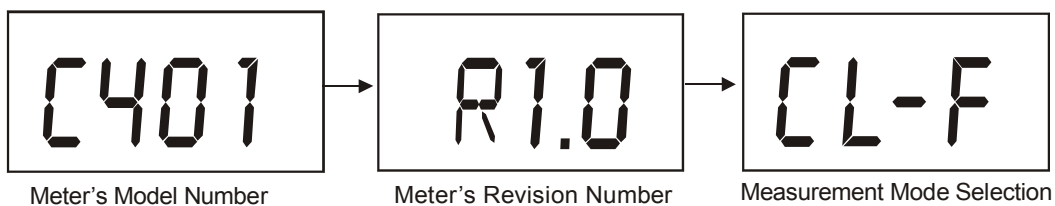

Figure 5: Power Up Sequence

An accurate colorimeter measurement depends on good measurement techniques. Factors such as clean sample vials, positioning of vial in the sample well, covering the vial with the light shield cap, meter calibration, handling of meter, and others, have to be taken into consideration.

NOTE: Do not pour liquid directly into the sample well of the instrument. Always use a vial. The instrument will only accurately measure the sample when vials sealed with the black caps are used. The black cap serves as both seal and a light shield.

NOTE: Do not attempt to clean the sample well. The optics may be damaged.

NOTE: This instrument is designed to measure solutions contained in the custom made glass vials and therefore the use of other type of sample vials or sample cells may result in inaccurate measurements.

2.2 Preparation of Sample Vial

1. Obtain a clean and dry sample vial (Figure 6).
2. Take care to handle the sample vial by the top.
3. Rinse the vial with approximately 10 ml of the sample water, capping the vial with the black screw cap and gently inverting it several times. Discard the used sample and repeat the rinsing procedure two more times.
4. Fill the rinsed vial with the remaining portion (approximately 10 ml) of the grab sample up to the mark indicated in the vial. Cap the vial with the supplied black screw cap.
5. Wipe the vial with a soft, lint-free cloth. Ensure that the outside of the vial is dry, clean and free from smudges.
6. You are now ready to place the vial into the meter for measurement.

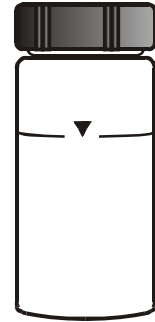

Figure 6:
Sample Vial

2.3 Measurement Procedure

1. Place C401/301/202/102/101 Colorimeter on a flat and level surface.
2. Place the sample vial inside the sample well and align the vial's mark with the meter's index mark. See Figure 8.

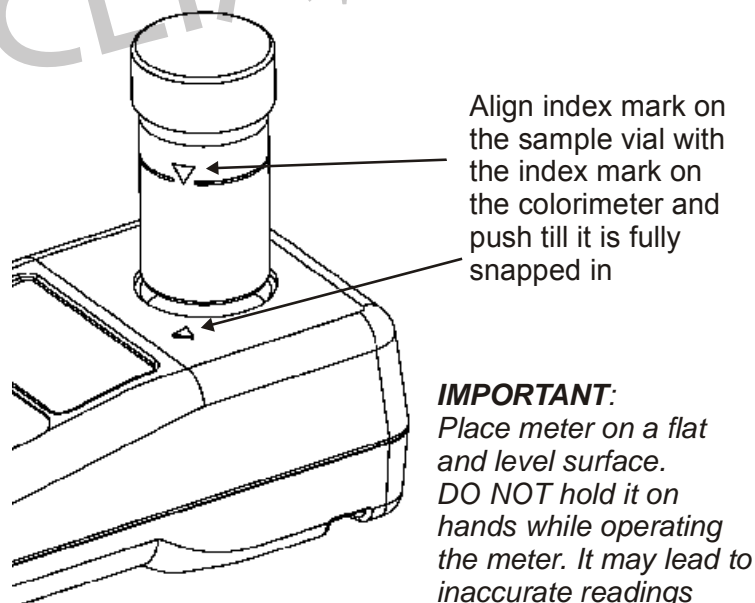

Figure 8: Sample vial index alignment to the meter's index mark

3. Push the vial until it is fully snapped in.
4. Turn on the meter by pressing the ON/OFF key. The display will

indicate the last test performed

5. Select the desired test to be performed by pressing the MODE key.
 6. Press the READ/ENTER key to confirm your selection. The meter will display [STbY] indicating it is ready to accept a measurement or a blanking.
 7. Press the ZERO key to perform the blanking of the meter. If the user chooses to skip this step, the meter will use the last value of the blank for the next calculation.
 8. Remove the sample vial used for blanking from the instrument and add the appropriate reagent to it. Cap the vial and follow the appropriate instructions (including the time required to develop the color) for each type of reagents.
 9. Place the vial with the developed color into the sample well and align the ▼ mark on the vial with the ▲ mark on the instrument, and press it down until it snaps fully into the optical holder.
 10. Press the READ/ENTER key. The meter will display the reading in appropriate units within 3 seconds.
 11. To repeat the measurement of the same sample, repeat steps 7-11. Ideally, step 7 should not be skipped, but the user may do so if testing the same sample.
- CLIA Waived™

2.4 Chlorine, Free & Total (0 – 6ppm Cl₂)

- DPD method¹ for Free Chlorine - applicable to water, treated water, estuary water and seawater.
- DPD method¹ for Total Chlorine - applicable to water, treated water, wastewater, estuary water and seawater.

The DPD Method is USEPA accepted for reporting drinking water analyses (Free and Total Chlorine) and wastewater analyses² (Total Chlorine only).

Note: ¹Adapted from "Standard methods for the Examination of Water and Wastewater."

Note: ²Procedure is equivalent to USEPA method 330.5 for wastewater and Standard Method 4500-Cl G for drinking water.

1. Switch the meter on by pressing the ON/OFF key.
2. Press the MODE key repeatedly until [CL – F] is displayed (for Free Chlorine determination) or [CL – T] is displayed (for Total Chlorine determination).
3. Press the READ/ENTER key to confirm the desired test parameter. The meter will read [STbY] indicating it is in stand-by mode, waiting for either blanking or measurement.



4. Select a clean and dry vial, un-screw the cap and fill with sample water to the line on the vial. Replace the cap, ensuring it is screwed on finger tight to the vial.
5. Ensure the outside of the vial is clean, dry and absent of any marks or finger-prints. Gently push the vial fully into the sample well of the instrument, whilst aligning the ▼ mark on the vial with the ▲ mark on the meter.
6. Press the ZERO key to initiate blanking of the meter. The display will show [ZERo] while blanking is taking place.

Note: The meter will store and use the last blanking (or zero) value, even if it is turned off, or if the batteries are removed.

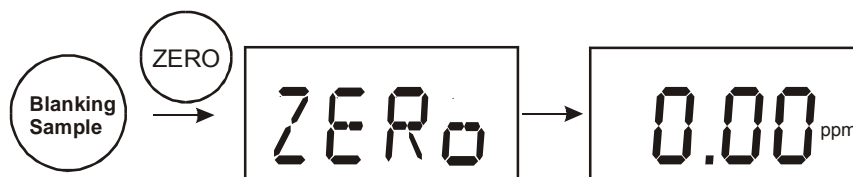

7. Remove the vial from the meter and add into it the content of one DPD Free sachet (for Free Chlorine determination) or the content of one DPD Total sachet (for Total Chlorine determination).
8. Replace the cap, ensuring it is screwed on finger tight to the vial. Invert the vial repeatedly for approximately 20 seconds, until the powder has dissolved.

Note: A small amount of the powder may remain un-dissolved in the vial, but this will not affect the measurement.

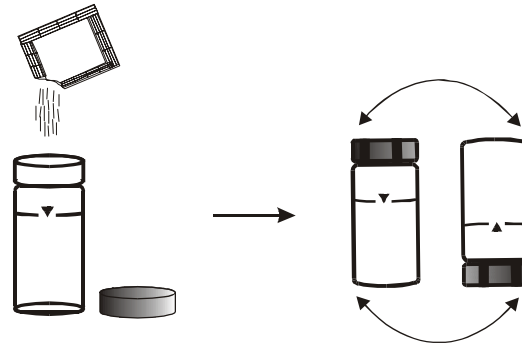

Add content of one DPD Free sachet (for Free Chlorine determination) or one DPD Total sachet (for Total Chlorine determination).

Invert vial approximately 20 seconds until powder dissolves

9. Gently push the vial back fully into the sample well of the meter, whilst again aligning the ▼ mark on the vial with the ▲ mark on the meter.
10. For Free Chlorine determination, press the READ/ENTER key within two minutes from the time the DPD Free reagent was added to the vial.
11. For Total Chlorine determination, wait for two minutes and then press the READ/ENTER key within four minutes from the time the DPD Total reagent was added to the vial.
12. The meter will flash either [CL-F] or [CL-T], depending on which test is being performed, whilst the measurement is taken. It will then display the Chlorine concentration in parts per million (ppm) Cl₂.

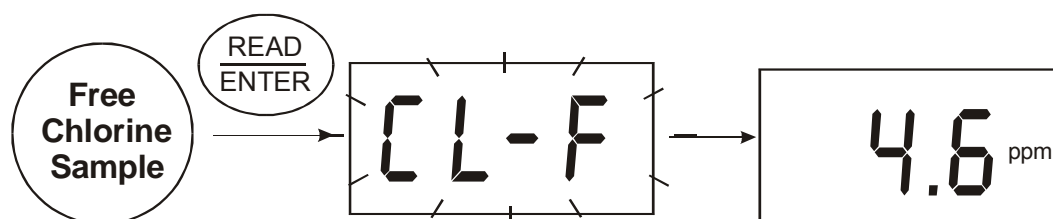

Chlorine, Free & Total Measuring Hints & Tips

2.4.1 Sample Collection

Chlorine determination must take place as soon as possible after the sample is taken or else low results may be obtained.

Plastic containers should not be used to collect the sample because these may have a high chlorine demand which will lead to low reading results. It is advisable to wash the container with sample water before the sample is collected.

Avoid agitating the sample excessively as this may also result in low results.

2.4.2 Sample Measurement

If the pink color forms and then rapidly fades, this is an indication that the chlorine concentration may be very high. If this is the case, dilute the sample with de-ionized water and retest. Multiply the result by the dilution factor used.

Example: if the sample was diluted 2:1 with de-ionized water (i.e. 1 part sample water to 1 part de-ionized water), the result is multiplied by 2 to give the true concentration of the original sample.

Note: Results obtained by this method will not be as accurate as stated in this manual because some chlorine will be lost in the dilution process.

After use, the vial should be cleaned thoroughly to avoid contaminating the next sample. Do not use household cleaners as these may have a chlorine demand which will lead to low results on subsequent tests.

After testing Total Chlorine give extra attention to cleaning the vial as any residual reagent will affect any subsequent Free Chlorine tests. It is advisable to use separate vials for Free and Total Chlorine.

2.4.3 Interferences

Acidity:

Greater than 250ppm CaCO₃ may cause interference. To remove this interference, neutralise a separate sample to pH6-7 using 1N Sodium Hydroxide. Record the volume used and add the same volume of 1N Sodium Hydroxide to the sample before carrying out the above test procedure. Use a multiplication factor to correct for the dilution of the sample.

Alkalinity:

Greater than 250ppm CaCO₃ may cause interference. To remove this interference, neutralise a separate sample to pH6-7 using 1N Sulphuric Acid. Note the volumes used and add the same volume of 1N Sulphuric Acid to the sample before carrying out the above test procedure. Use a multiplication factor to correct for the dilution of the sample.

Hardness:

No effect at less than 2000ppm CaCO₃.

Monochloramine:

Monochloramine will cause a gradual increase in the Free Chlorine result over time. Take the test result within 1 minute of adding the reagent sachet to avoid these errors.

Oxidants, including Bromine, Chlorine Dioxide, Iodine and Ozone:

These will interfere with the test method at all levels. It is recommended that an alternative test method is used if these species are present.

Oxidised Manganese or Oxidised Chromium:

All levels will cause interference. To remove this interference:

1. Test a 10ml sample as described in the above procedure.
2. Adjust the pH of a separate 10ml sample to pH6-7 using 1N Sodium Hydroxide or 1N Sulphuric Acid.
3. Add 1 drop of 20% Potassium Iodide Solution; swirl to mix and then wait 60 seconds.
4. Add 3 drop of 5g/l Sodium Arsenite Solution and swirl to mix.
5. Use this as the sample in the above test procedure and make a note of the result. Use a multiplication factor to correct for the dilution of the sample.

6. Subtract the result obtained in step 5 from the result obtained in step 1 to give the true result.

2.4.4 Correcting for dilution

To correct for any reagent added to the sample to neutralise it, a dilution correction factor must be used:

$$\text{Final Volume} \div \text{Initial Sample Volume} = \text{Correction Factor}$$

The final volume can be calculated by adding together the initial sample volume and the volume of neutralising reagent used:

$$\text{Final Volume} = \text{Initial Sample Volume} + \text{Volume of Neutralising Reagent.}$$

The result from a test can then be multiplied by the Correction Factor to give the true result.

If reagents are added from the supplied dropper bottles, then 25 drops is equal to 1ml.

Example:

50ml sample is neutralised using 50 drops of 1NTM Sulphuric Acid, and each drop is 0.04 ml.

$$\text{Initial Sample Volume} = 50\text{ml}$$

$$\text{Volume of Neutralising Reagent added} = 50\text{drops} \times 0.04 \text{ ml} = 2\text{ml}$$

$$\text{Final Volume} = 50\text{ml} + 2\text{ml} = 52\text{ml}$$

$$\text{Correction Factor} = 52/50 = 1.04$$

A test result of 1.00ppm would then become $1.00\text{ppm} \times 1.04 = 1.04\text{ppm}$

2.4.5 Accuracy Check / User Calibration

Producing chlorine standards is a difficult procedure that should only be attempted by trained laboratory staff. Details of preparation techniques are not provided in this document.

The prepared chlorine standard may be used to check the accuracy of the meter or to re-calibrate the meter. In almost all cases it is recommended to use the default factory calibration.

To check the accuracy of the meter: Prepare a standard in the range 0-6ppm (it is advisable to check a standard at near the concentration usually tested for using the meter). Use this standard in place of the sample water in the above test method. Repeat the measurement 5-7 times with different sachets and average the results. The result obtained should be approximately the value of the standard used (please refer to instrument's specifications for data on meter precision and accuracy).

To re-calibrate the meter: All instruments are factory calibrated and user calibration is not recommended. However, if a Chlorine standard can be prepared, measured accurately and qualified by a different method (titration, for example) or another instrument of higher precision and accuracy, then a Chlorine standard in the 4.1-5.0 ppm Cl_2 range can be used. Please refer to Section 3.2 Chlorine, Free & Total, for details.

2.4.6 Chemistry

Chlorine exists in water as Un-Combined (Free) Chlorine and Combined Chlorine. The concentration of Free Chlorine can be determined directly and the concentration of Combined Chlorine may be calculated by subtracting the concentration of Free Chlorine from that of Total Chlorine.

In the Free Chlorine test method Un-Combined Chlorine reacts directly with DPD (N,N-diethyl-p-phenylenediamine) in a conditioned sample to give a pink color. In the Total Chlorine test method Combined Chlorine reacts with potassium iodide to form tri-iodide ions. The tri-iodide ions and the Free Chlorine present react with DPD in a conditioned sample to give a pink color.

The depth of the pink color produced is proportional to the concentration of Chlorine. The amount of 525nm light absorbed by the pink color is accurately measured by the meter and then converted into the Chlorine concentration.

CLIAwaived.com

2.5 Cyanuric Acid (5-90 ppm)

• For water and treated water

1. Switch the meter on by pressing the ON/OFF key.
2. Press the MODE key repeatedly until [CYNA] is displayed.
3. Press the READ/ENTER key to confirm the test parameter. The meter will read [STbY] indicating it is in stand-by mode, waiting for either blanking or measurement.

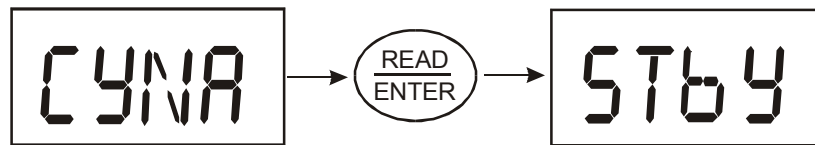

4. Select a clean and dry vial, un-screw the cap and fill with sample water to the line on the vial. Replace the cap, ensuring it is screwed on finger tight to the vial.
5. Ensure the outside of the vial is clean, dry and absent of any marks or finger-prints. Gently push the vial fully into the meter, whilst aligning the ▼ mark on the vial with the ▲ mark on the meter.
6. Press the ZERO key to blank the meter to that vial; the meter will read [ZERo] whilst this is taking place.

Note: The meter will store the last zero value it took between tests, even if it turns off or if the batteries are removed.

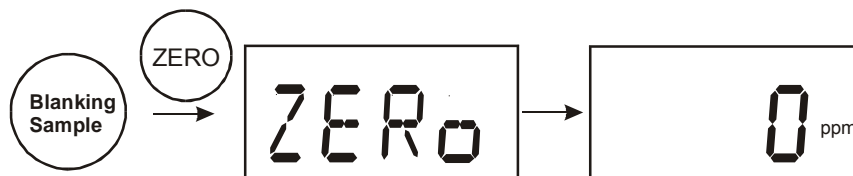

7. Remove the vial from the meter and un-screw the cap. Select a Cyanuric Acid reagent sachet. Open the sachet and tip the contents into the vial.
8. Replace the cap, ensuring it is screwed on finger tight to the vial. Shake the vial for 1 minute.

Note: a small amount of the powder may remain un-dissolved in the vial, but this will not affect the reading.

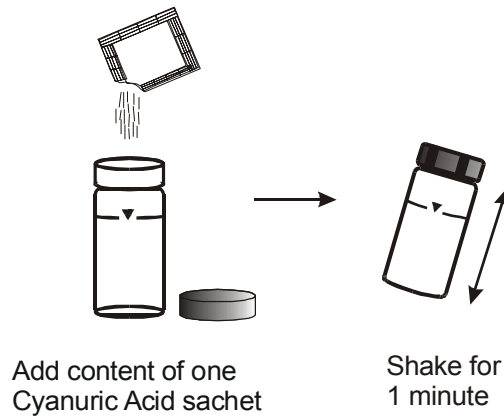

9. Gently push the vial back fully into the sample well of the instrument, whilst again aligning the ▼ mark on the vial with the ▲ mark on the meter.
10. Wait for two minutes and then press the READ/ENTER key within five minutes from when the sachet was added to the vial.
11. The meter will flash [CYNA] whilst the measurement is taken. It will then display the Cyanuric Acid concentration in parts per million (ppm).

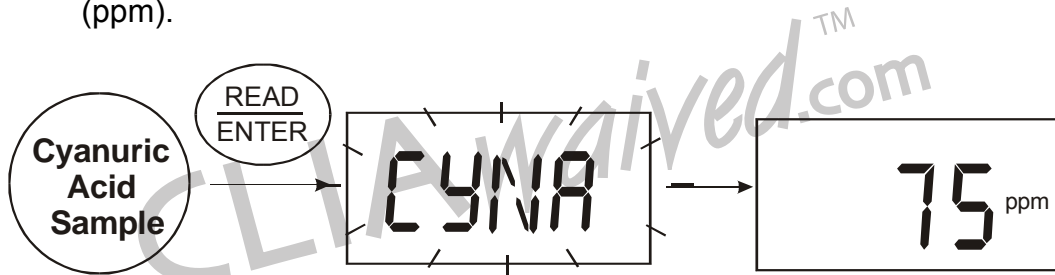

*Cyanuric Acid
Measuring Hints & Tips*

2.5.1 Sample Collection

Samples may be collected in either plastic or glass bottles. It is advisable to wash the container with sample water before collecting the sample.

Do not store the sample for more than 24 hours before conducting the analysis.

2.5.2 Sample Measurement

Due to the nature of the test method, concentrations less than 5 ppm Cyanuric Acid are not detectable.

Clean the vial immediately after taking and recording a reading. Do not leave the sample with added reagent into the vial for more than few minutes after measurement. The test will cause the build up of a cloudy layer on the inside wall of the vial. It is important to thoroughly clean the vial after use to remove this layer because subsequent test results may be affected.

2.5.3 Interferences

Sample Turbidity:

Turbid samples should be filtered prior to analysis.

2.5.4 Accuracy Check / User Calibration

A stock solution of 1000ppm Cyanuric Acid may be produced by dissolving exactly 1g of Cyanuric Acid in 1 litre of de-ionised water (check the purity of the Cyanuric acid being used; if less than 100%, adjust the amount used accordingly).

The stock solution may then be diluted to give a Cyanuric Acid standard. To do this take a portion of the stock solution and make up to 1 litre using de-ionised water (for example, 50ml of stock solution will produce a 50ppm standard).

To check the accuracy of the meter: Prepare a standard in the range 20-80 ppm (it is advisable to check a standard at near the concentration usually tested for using the meter). Use this standard in place of the sample water in the above test method. The result obtained should be approximately the value of the standard used (please refer to instrument's specifications for data on meter precision and accuracy).

To re-calibrate the meter: All instruments are factory calibrated and user calibration is not recommended. However, if a Cyanuric Acid standard can

be accurately prepared, or measured by a different method or instrument of higher precision and accuracy, then a Cyanuric Acid standard in the 66-75 ppm range can be used. Please refer to section 3.3 Cyanuric Acid for details.

2.5.5 Chemistry

Cyanuric Acid is commonly used to stabilize the chlorine present in swimming pool water. With correct pool maintenance, Cyanuric Acid build-up is uncommon; however, if correct maintenance is not carried out, the levels may build up until potentially harmful.

In the test method, the Cyanuric acid reacts with the sachet reagent, in a conditioned sample, to produce a suspended turbidity.

The amount of turbidity produced is proportional to the concentration of Cyanuric Acid. The amount of 525nm light absorbed/scattered by the turbidity is accurately measured by the meter and then converted into the Cyanuric Acid concentration.

CLIAwaivedTM.com

2.6 pH (5.9-8.2 pH units)

• For water and wastewater (Phenol Red Method)

1. Switch the meter on by pressing the ON/OFF key.
2. Press the MODE key repeatedly until [PH] is displayed.
3. Press the READ/ENTER key to confirm the test parameter. The meter will read [STbY] indicating it is in stand-by mode, waiting for either blanking or measurement.

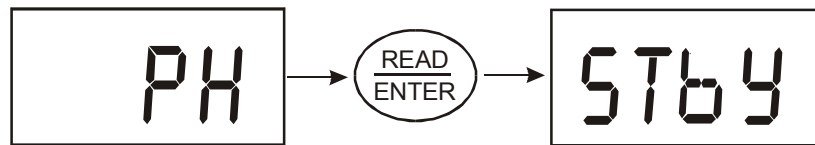

4. Select a clean and dry vial, un-screw the cap and fill with sample water to the line on the vial. Replace the cap, ensuring it is screwed on finger tight to the vial.
5. Ensure the outside of the vial is clean, dry and absent of any marks or finger-prints. Gently place the vial fully into the sample well of the instrument, whilst aligning the ▼ mark on the vial with the ▲ mark on the meter.
6. Press the ZERO key to blank the meter to that vial; the meter will read [ZERo] whilst this is taking place.

Note: The meter will store the last zero value it took between tests, even if it turns off or if the batteries are removed.



7. Remove the vial from the meter and un-screw the cap. Select a bottle of pH Indicator (Phenol Red) reagent. Unscrew the cap and holding the bottle vertically; gently squeeze 20 drops of reagent into the contents into the vial. Replace the cap onto the reagent bottle. Take extra care not to over-tighten the cap.
8. Replace the cap onto the vial, ensuring it is screwed on finger tight. Invert the vial several times to mix.

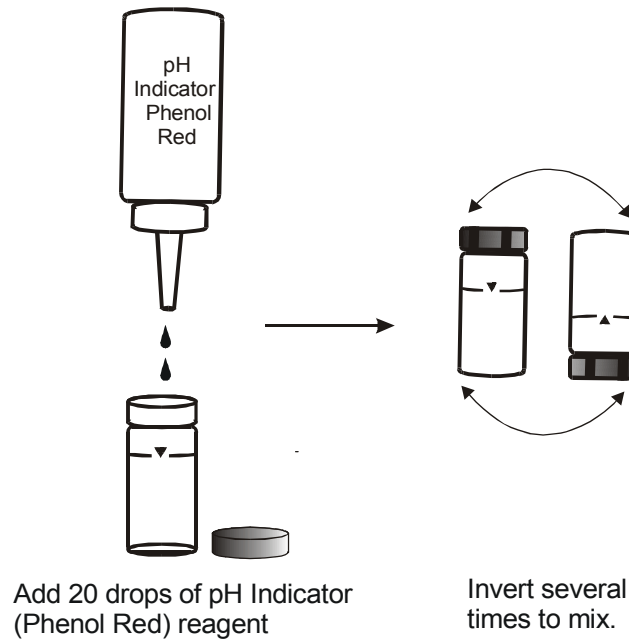

9. Gently push the vial back fully into the sample well of the instrument, whilst again aligning the ▼ mark on the vial with the ▲ mark on the meter.
10. Wait for 1 minute and then press the READ/ENTER key within 3 minutes from when the time the reagent was added to the vial.
11. The meter will flash [PH] whilst the measurement is taken. It will then display the pH of the solution in pH units.



pH Measuring Hints & Tips

2.6.1 Sample Collection

Samples may be collected in either plastic or glass bottles. It is advisable to wash the container with sample water before the sample is collected.

For accurate results, analysis should be conducted as soon as possible after sample collection.

2.6.2 Sample Measurement

The amount of sample used and the amount of reagent added is critical to obtaining correct test results. Ensure that the reagent is added in a consistent manner, with the dropper bottle being held vertically and squeezed slowly. To increase the test accuracy, measure the 10ml sample and reagent using calibrated pipettes. Note: 20 drops of reagent = 0.8ml.

It is important to re-calibrate the meter to each new batch of reagent used, or if the reagent has not been used for more than a month. It is also important to occasionally check the results obtained with a colorless pH7.0 buffer solution. If the result is outside the range pH6.9-7.1 re-calibrate the meter (please refer to section 3.4 pH).

Due to the nature of the test method, a sample pH of less than 5.9 or greater than 8.2 may result in false readings. Do not use this test method to analyze samples with a pH outside of the specified range.

2.6.3 Interferences

Chlorine:

Chlorine concentrations of greater than 6ppm may interfere. To remove this interference, add a crystal of Sodium Thiosulphate to the sample and mix, before adding the reagent.

2.6.4 Accuracy Check / User Calibration

A colorless pH7.0 buffer (supplied) can be used to check the test accuracy and strength of reagent.

To check the accuracy of the meter: Use a colorless pH7.0 buffer in place of the sample water in the above test method. The result obtained should be in the range pH6.9-7.1 (please refer to instrument's specifications for data on meter precision and accuracy).

To re-calibrate the meter: Please refer to section 3.4 pH for details.

2.6.5 Chemistry

The monitoring and control of the pH of water is important in many different applications. This test method provides a quick and accurate method for measuring pH in the range pH5.9 - 8.2.

A precise amount of phenol red indicator is added to a sample of water. The phenol red changes color from yellow at pH5.9 through to dark red at pH8.2.

The amount of red color is related to its pH. The amount of 525nm light absorbed by the red color is accurately measured by the meter and then converted into the pH of the sample.

CLIAwaivedTM.com

3 CALIBRATION

The C401/301/201/102/101 Colorimeter was calibrated and tested prior to leaving the factory. Therefore, it is possible for you to use the instrument directly out of the box. Re-calibration of the instrument is NOT recommended particularly in the case of chemical tests of very unstable and/or difficult to prepare calibration solutions. However, the meter allows you to calibrate in one point for each chemical test fitted in the instrument. It is recommended to calibrate the pH at 7.0 pH units using the supplied colorless 7.0 pH buffer.

For each of the chemical tests fitted in the instrument, the Colorimeter requires only one standard solution for a complete calibration. During calibration, the instrument performs several system self-diagnostics. As such, several warning messages will be displayed. If the instrument detects an irregularity with either the detector or the lamp, a warning message will be displayed during or upon exiting the calibration mode. If this occurs, attempt to rectify the situation as indicated in Section 4 Troubleshooting Guide. In any event, the instrument will continue to read the concentration or pH, but with a decreased accuracy until the error is rectified.

The meter has an auto exit feature whereby it will exit the calibration mode if no key is pressed within 10 minutes or if there is an error during calibration.

A light shield cap is added in the package as an optional accessory to shield off stray light during calibration and measurements.

3.1 Calibration Procedure

The standard calibration solutions are to be prepared in the ranges indicated in the specifications. Standard solutions should be measured accurately and qualified by a different method or another instrument of higher precision and accuracy.

NOTE: Do not pour liquid directly into the sample well of the instrument. Always use a vial. The instrument will only accurately measure the sample when vials sealed with the black caps are used. The black cap serves as both seal and a light shield.

NOTE: Do not attempt to clean the sample well. The optics may be damaged.

NOTE: This instrument is designed to measure solutions contained in the custom made glass vials and therefore the use of other type of sample vials or sample cells may result in inaccurate measurements.

3.2 Chlorine, Free & Total

1. Prepare a Chlorine standard in the 4.1-5.0 ppm Cl₂ range, measure and record the concentration value.
2. Ensure the meter is switched off. Press and hold the ZERO key while switching the meter on by pressing the ON/OFF key. The meter will momentarily flash the model number and then display the CAL annunciator at the top left corner of the screen indicating the instrument is in calibration mode.
3. Press the MODE key repeatedly until [CL-F] (for calibrating Chlorine Free), or [CL-T], (for calibrating Chlorine Total), is displayed.

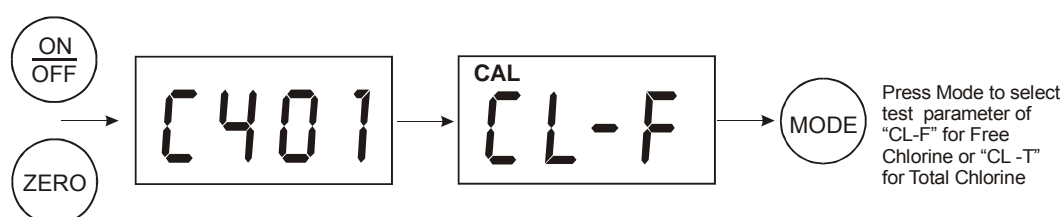

4. Press the READ/ENTER key to confirm the selected test. The meter will display [bLNK] indicating it is waiting for a blanking sample.

NOTE: Blanking is compulsory during calibration; without blanking the meter will not continue with the calibration procedure.



5. Select a clean vial, unscrew the cap and fill with deionised water to the line on the vial. Replace the cap, ensuring it is screwed on finger tight to the vial.
6. Ensure the outside of the vial is clean, dry and absent of any marks or finger-prints. Gently push the vial fully into sample well of the instrument, whilst aligning the ▼ mark on the vial with the ▲ mark on the meter.
7. Press the ZERO key to blank the meter to that vial; the meter will display [ZERo] whilst this is taking place.
8. Remove the blanking vial from the meter. The meter displays 4.1 ppm, with the CAL annunciator on the top left corner.
9. Use the MODE key repeatedly to select the concentration of the prepared calibration standard in the 4.1 - 5.0 ppm range.

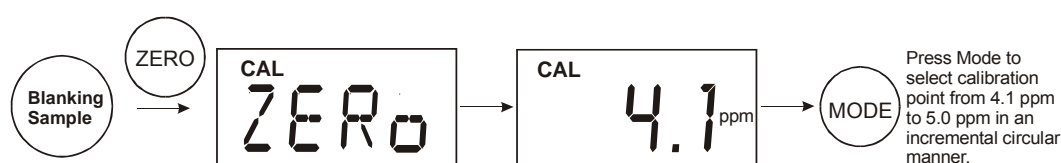

10. Select another clean vial, un-screw the cap and fill it with 10 ml of the prepared Chlorine standard (fill up to the line on the vial).
11. Select a DPD Free sachet, or a DPD Total sachet, depending on the selected test. Open the sachet and tip the contents into the vial containing the calibration standard.
12. Replace the cap, ensuring it is screwed on finger tight to the vial. Invert the vial repeatedly for approximately 20 seconds, until the powder has dissolved.

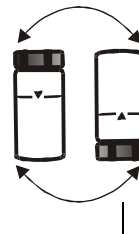

NOTE: a small amount of the powder may remain un-dissolved in the vial, but this will not affect the measurement.

13. Insert the vial fully into the sample well of the meter, whilst again aligning the ▼ mark on the vial with the ▲ mark on the meter.
14. For Free Chlorine calibration, press the READ/ENTER key within two minutes from the time the sachet was added to the vial. As for Total Chlorine calibration, wait for two minutes before pressing the READ/ENTER key and this has to be done within five minutes from the time the sachet was added to the vial.
15. The meter will display [--Rd--] whilst the calibration standard is being measured and then displays [SAVE] to prompt for calibration acceptance and saving of calibration data.

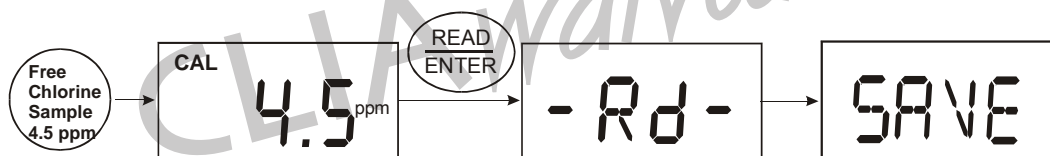

16. Press the READ/ENTER key. The meter now accept the calibration value and momentarily display [HoLD] and CAL annunciator before returning to the beginning of the calibration as in step 4.
17. To continue with another calibration, press the MODE key to select the desired calibration mode.
18. To exit calibration mode, press ZERO key to return to the measurement mode.

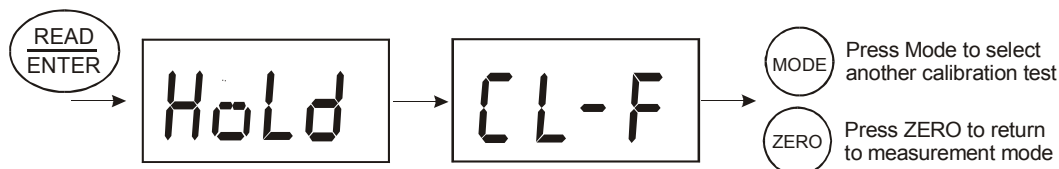

NOTE: If you wish to abort the calibration process, do NOT press the READ/ENTER key as in step 16. Press the ZERO key instead. The meter will display [AbRT] and CAL annunciator to signify that the calibration has been aborted without saving the calibration value. The meter will then return to the beginning of the user calibration as in step 4.

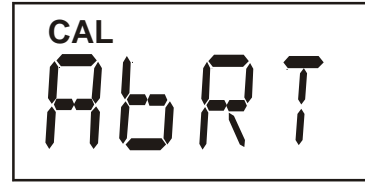

NOTE: If an error occurs during calibration, the display will present an error message. Please refer to Section 4 Troubleshooting Guide for details.

CLIAwaivedTM.com

3.3 Cyanuric Acid

1. Prepare a Cyanuric Acid standard solution in the 66 - 75 ppm range and record the concentration value.
2. Ensure the meter is switched off. Press and hold the ZERO key while switching the meter on by pressing the ON/OFF key. The meter will momentarily flash the model number and then display the CAL annunciator at the top left corner of the screen indicating the instrument is in calibration mode.
3. Press the MODE key repeatedly until [CYNA] is displayed.

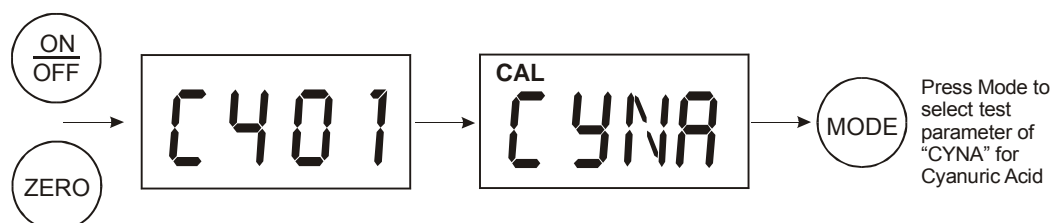

4. Press the READ/ENTER key to confirm the selected test. The meter will display [bLNK] indicating it is waiting for a blanking sample.

Note: blanking is compulsory during calibration; without blanking the meter will not continue with the calibration procedure.



5. Select a clean vial, un-screw the cap and fill with de-ionised water to the line on the vial. Replace the cap, ensuring it is screwed on finger tight to the vial.
6. Ensure the outside of the vial is clean, dry and absent of any marks or finger-prints. Gently place the vial fully into sample well of the instrument, whilst aligning the ▼ mark on the vial with the ▲ mark on the meter.
7. Press the ZERO key to blank the meter to that vial; the meter will display [ZERo] whilst this is taking place.
8. Remove the blanking vial from the meter.
9. The meter displays 66 ppm, with the CAL annunciator on the top left corner.
10. Use the MODE key repeatedly to select the concentration of the prepared calibration standard in the 66 - 75 ppm range.

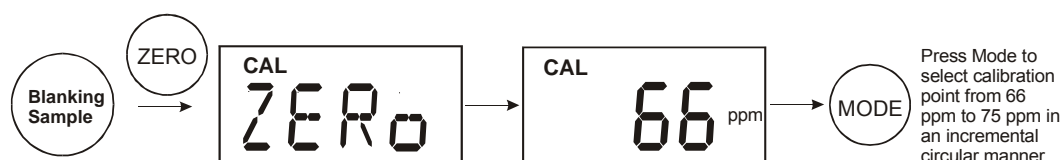

11. Select another clean vial, un-screw the cap and fill it with 10 ml of the prepared Cyanuric Acid standard solution (fill up to the line on the vial).

12. Select a Cyanuric Acid sachet. Open the sachet and tip the contents into the vial containing the calibration standard.

13. Replace the cap, ensuring it is screwed on finger tight to the vial. Shake the vial for approximately one minute, until the powder has dissolved.



Note: a small amount of the powder may remain un-dissolved in the vial, but this will not affect the measurement.

14. Insert the vial fully into the sample well of the meter, whilst again aligning the ▼ mark on the vial with the ▲ mark on the meter.

15. Wait for two minutes, then press the READ/ENTER key within five minutes from the time the reagent was added to the vial.

16. The meter will display [--Rd--] whilst the calibration standard is being measured and then displays [SAVE] to prompt for calibration acceptance and saving of calibration data.

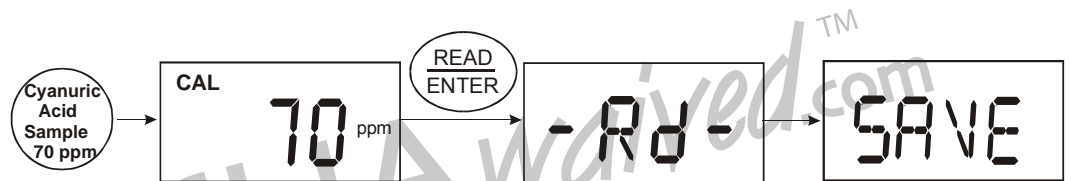

17. Press the READ/ENTER key. The meter will now accept the calibration value and momentarily display [HoLD] and CAL annunciator before returning to the beginning of the calibration as in step 4.

18. To continue with another calibration, press the MODE key to select the desired calibration mode.

19. To exit the calibration mode, press the ZERO key to return to the measurement mode.

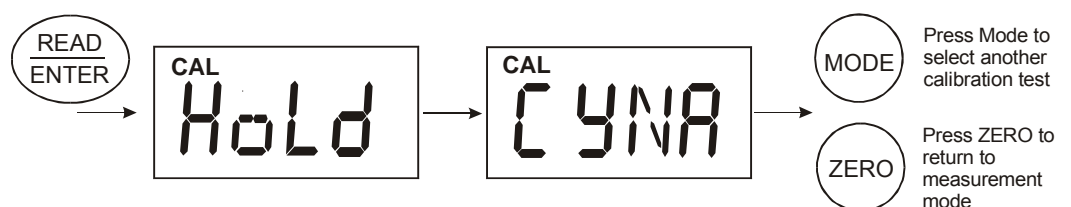

NOTE: If you wish to abort this calibration process, do NOT press the READ/ENTER key as in step 17. Press the ZERO key instead. The meter will display [AbRT] and CAL annunciator to signify that the calibration has been aborted without saving the calibration value. The meter will then return to the beginning of the user calibration as in step 4.

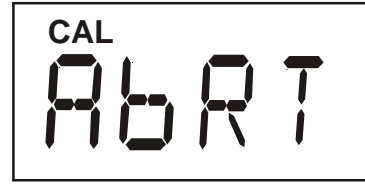

NOTE: If an error occurs during calibration, the display will present an error message. Please refer to Section 4 Troubleshooting Guide for details.

CLIAwaivedTM.com

3.4 pH

1. Ensure at least 10 ml of clear pH7.0 buffer is available.
2. Ensure the meter is switched off.
3. Press and hold the ZERO key while switching the meter on by pressing the ON/OFF key. The meter will momentarily flash the model number and then display the CAL annunciator at the top left corner of the screen indicating the instrument is in calibration mode.
4. Press the MODE key repeatedly until [PH] is displayed.

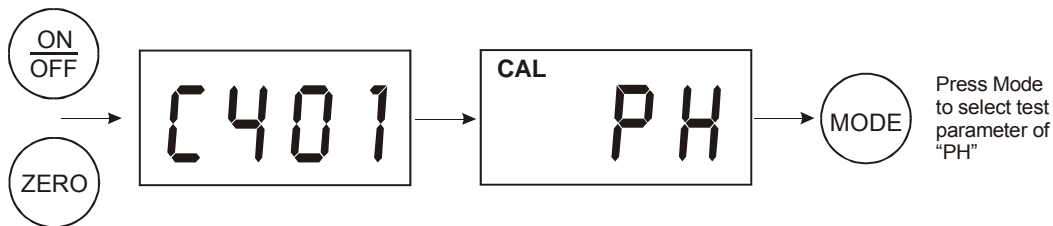

5. Press the READ/ENTER key to confirm the selected test. The meter will display [bLNK] indicating it is waiting for a blanking sample.

Note: blanking is compulsory during calibration; without blanking the meter will not continue with the calibration procedure.



6. Select a clean vial, un-screw the cap and fill with de-ionised water to the line on the vial. Replace the cap, ensuring it is screwed on finger tight to the vial.
7. Ensure the outside of the vial is clean, dry and absent of any marks or finger-prints. Gently push the vial fully into sample well of the instrument, whilst aligning the ▼ mark on the vial with the ▲ mark on the meter.
8. Press the ZERO key to blank the meter to that vial; the meter will read [ZERo] whilst this is taking place.
9. Remove the blanking vial from the meter.
10. The meter displays 7.0 pH, with the CAL annunciator on the top left corner.

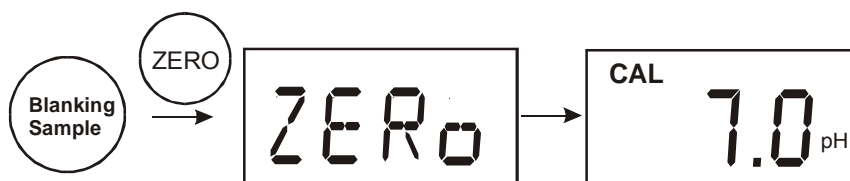

- Select another clean vial, un-screw the cap and fill it with 10 ml of the pH7.0 colorless buffer. (fill up to the line on the vial).

Note: A proper calibration requires exactly 10 ml volume of pH7.0 buffer.

- Select a bottle of pH Indicator (Phenol Red) reagent. Unscrew the cap and holding the bottle vertically; gently squeeze 20 drops of reagent into the contents into the vial. Replace the cap onto the reagent bottle. Be careful not to over-tighten the cap.

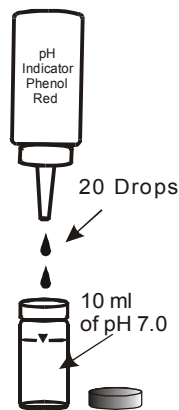

- Replace the cap onto the vial, ensuring it is screwed on finger tight. Invert the vial several times to mix.
- Gently place the vial into the sample well of the instrument, whilst again aligning the ▼ mark on the vial with the ▲ mark on the meter.
- Wait for one minute and then press the READ/ENTER key within 3 minutes from when the time the reagent was added to the vial.
- The meter will display [--Rd--] whilst the calibration standard is being measured and then displays [SAVE] to prompt for calibration acceptance and saving of calibration data.

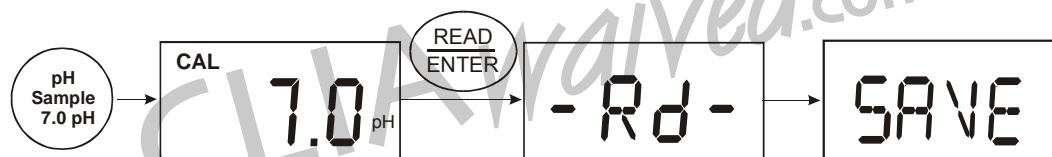

- Press the READ/ENTER key. The meter will now accept the calibration value and momentarily display [HoLD] and CAL annunciator before returning to the beginning of the calibration as in step 4.
- To continue with another calibration, press the MODE key to select the desired calibration mode.
- To exit the calibration mode, press the ZERO key to return to the measurement mode.

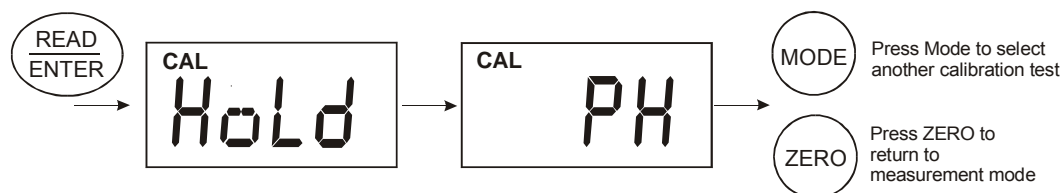

NOTE: If you wish to abort this calibration process, do NOT press the READ/ENTER key as in step 17. Press the ZERO key instead. The meter will display [AbRT] and CAL annunciator to signify that the calibration has been aborted without saving the calibration value. The meter will then return to the beginning of the user calibration as in step 4.

NOTE: If an error occurs during calibration, the display will present an error message. Please refer to Section 4 Troubleshooting Guide for details.

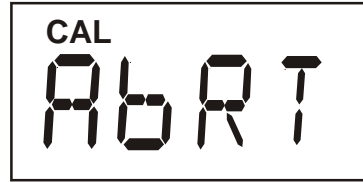

CLIAwaivedTM.com

3.5 **Restoring Factory Calibration**

The C401/301/201/102/101 Colorimeter allows you to reset the meter back to the factory default calibration values. This feature is extremely useful when there are errors in calibration or when you have new calibration standards.

1. With the meter switched off, press MODE and ON/OFF keys simultaneously for about 2 seconds.
2. The meter will momentarily flash the model number and [URST] (User-Reset) and then display [No].
3. Use MODE key to select between [YES] or [No].
 - [YES] = To restore meter back to factory calibration values
 - [No] = To retain last calibrated values
4. After selecting [YES] or [No], press READ/ENTER key.
5. The meter will now flash the model number, the meter's revision number and enter the measurement selection mode.

Figure 9 shows the sequence for restoring factory calibration values.

CLIAwaivedTM.com

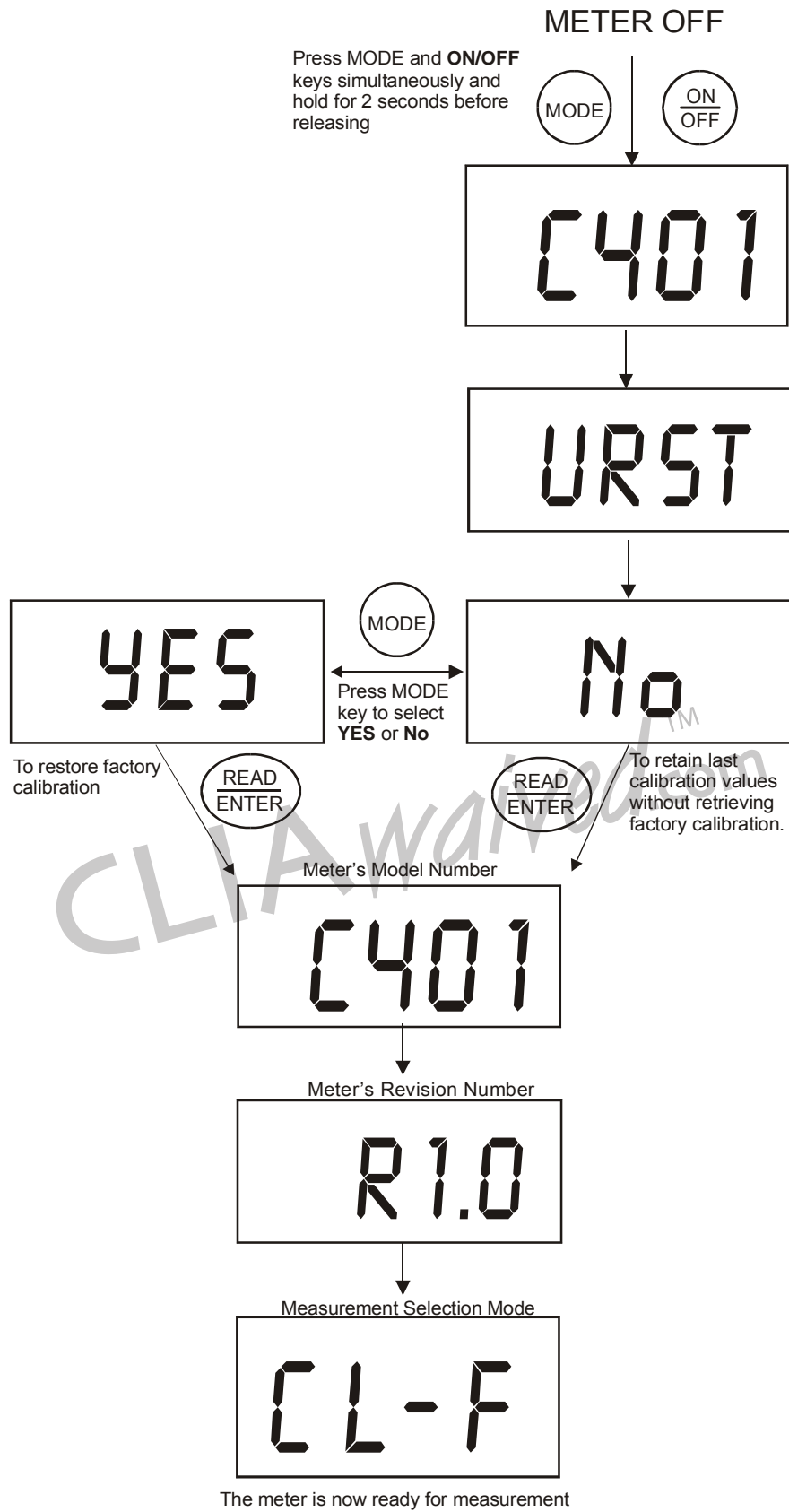



Figure 9: Restoring Factory Calibration

4 TROUBLESHOOTING GUIDE

The C401/301/201/102/101 Colorimeter routinely performs self-diagnostics, and will automatically generate messages to provide you with specific diagnostic information. These messages are for your use and do not indicate a reduction in the performance of the instrument or a failure of any component in the instrument, unless otherwise stated in this list.

LCD Message	Description	Corrective Actions
OR	When measured concentration (or pH value) is above the measurement range (chemistry test specific)	Ensure sample value is within the measurement range as listed in the Specification table in Section 7.
UR	When measured concentration (or pH value) is below the measurement range (chemistry test specific)	Ensure sample value is within the measurement range as listed in the Specification table in Section 7.
*ERR0	Inappropriate signal to recognize the blank. Sample absorbance is less than blanking or blanking too low to achieve specified resolution.	Ensure that blanking is done before the chemical reagent is added. Repeat the blanking procedure.
*ERR1	Calibration Failure. The absorbance of the calibration standard is outside the range allowed for the selected calibration point.	Ensure calibration standard is accurately prepared. Replace calibration standard with a known accurate value and recalibrate.
*ERR2	Excessive stray light detected.	Ensure the vial is fully snapped in the sample well.
*ERR3	Lamp Failure. LED is faulty.	Return the unit for repair.
	Low battery indication. The batteries need to be replaced.	Replace the batteries.

* If an error message appears, take the appropriate corrective action and re-do the desired procedure. If the problem persists, contact Eutech Instruments or your dealer. See Sections on Warranty and Return of Items on page 39.



5 ROUTINE MAINTENANCE

The supplied carrying case is optimal for protecting the instrument. If you do not plan on leaving the instrument in the supplied carrying case, when not in use, ensure that the instrument has been turned off and that a clean sample vial fitted with a black cap has been placed in the sample well. This will ensure that a minimal amount of dust and/or debris will be able to settle on the optics of the instrument.

5.1 Vials – Handling, Cleaning and Care

Proper colorimetric measurement of a sample requires the use of a vial that is free of marks, smudges, scratches and any bacterial growth.

Therefore, sample vials must be handled with absolute care to avoid contamination or damage, which might change the optical characteristics of the glass. Scratches, fingerprints, and water droplets on the sample vial or inside the sample well can cause stray light interference leading to inaccurate readings.

Cleaning the vial is accomplished by washing the interior and exterior of the vial in a detergent solution. Once cleaned, the vial should be rinsed thoroughly 8 to 10 times with clean distilled water to eliminate the possibility of detergent buildup and streaking.

Sample vials should always be handled from the top or by the cap to avoid fingerprints or smudges. After a vial has been filled with a sample and capped, the outside surface should be wiped with a clean, lint-free absorbent cloth until it is dry. Cleaned and dried vials should be stored with the black caps on. The vial can be stored in the carrying case. During normal operation you may use any typical glass cleaner along with a lint free cloth or tissue (Kimwipes®), to clean the outside of the vials.

6 ACCESSORIES

The items shown below are recommended accessories and replacement parts for the instrument.

Item Description	Eutech Instruments Order Code.	Oakton Instruments Order Code.
pH Colorimeter with sample vials, a 30 ml bottle, pH Indicator (Phenol Red) Reagent Kit and batteries in a rugged carrying case	ECC101	35645-10
Cyanuric Acid Colorimeter with sample vials, Cyanuric Acid Reagent Kit and batteries in a rugged carrying case	ECC102	35645-12
Free/ Total Chlorine Colorimeter with sample vials, Chlorine, Free (DPD) Reagent Kit, Chlorine, Total (DPD) Reagent Kit and batteries in a rugged carrying case	ECC201	35645-20
Free/ Total Chlorine/ pH Colorimeter with sample vials, a 30 ml bottle, Chlorine, Free (DPD) Reagent Kit, Chlorine, Total (DPD) Reagent Kit, pH Indicator (Phenol Red) Reagent Kit and batteries in a rugged carrying case	ECC301	35645-30
Free/ Total Chlorine/ pH/ Cyanuric Acid Colorimeter with sample vials, a 30 ml bottle, Chlorine, Free (DPD) Reagent Kit, Chlorine, Total (DPD) Reagent Kit, pH Indicator (Phenol Red) Reagent Kit, Cyanuric Acid Reagent Kit and batteries in a rugged carrying case	ECC401	35645-40
Sample Vials – pack of 3 vials	ECTN100CU VKT	35653-55
pH Indicator (Phenol Red) Reagent Kit	94X377004	35645-60
Cyanuric Acid Reagent Kit	94X377003	35645-62
Chlorine, Free (DPD) Reagent Kit	94X377001	35645-64
Chlorine, Total (DPD) Reagent Kit	94X377002	35645-66

7 SPECIFICATIONS

Measurement Method	Photometric
Light Source	Light Emitting Diode (LED)
Wavelength	525 nm
Detector	Silicon photodiode
Absorbance Range	0 – 2.5 Abs
Photometric Precision	+/- 0.0015 Abs
Automatic Range Selection	0 – 1.99 ppm (Free & Total Chlorine) 2.0 – 6.0 ppm (Free & Total Chlorine) 5.9 – 8.2 pH 5 – 90 ppm (Cyanuric Acid)
Resolution	0.01 ppm (0 – 1.99 ppm; Free & Total Chlorine) 0.1 ppm (2.0 – 6.0 ppm; Free & Total Chlorine) 0.1 pH (5.9 – 8.2 pH) 1 ppm (5 – 90 ppm; Cyanuric Acid)
Accuracy	+/- 0.02 ppm (0 – 1.99 ppm; Free & Total Chlorine) +/- 0.2 ppm (2.0 – 6.0 ppm; Free & Total Chlorine) +/- 0.1 pH (5.9 – 8.2 pH) +/- 4 ppm; Cyanuric Acid
Calibration Points	User selectable; 1 point per colorimetric test
Display	4-digit 14-segments customized liquid crystal display with annunciators
Sample Cells	Borosilicate glass with screw caps, fill line and indexing mark Height x diameter: 51 x 25 mm (2 x 1 in)
Sample Required	10 ml (0.33 oz)
Operating Temperature Range	0 – 50°C (32°F to 122°F)
Sample Temperature Range	0 – 50°C (32°F to 122°F)
Operating Humidity Range	0-90% RH non-condensing at 30°C (86°F)
Power Supply	4 AAA alkaline batteries
Battery Life	> 3000 tests
Electromagnetic Compliance (EMC)	Emitted Interference - EN 61326 Immunity to Interference - EN 61326
Enclosure Rating	IP67
Insulation Rating	Pollution degree 2
Weight	Instrument: 200 g (7 oz) Instrument in carrying case: 1.25 kg (2.75 lb)
Dimensions	Instrument: 6.8(W) x 15.5(L) x 4.6(H) cm; (2.7 x 6.1 x 1.8 in) Carrying case: 16(W) x 35(L) x 12(H) cm; (6.3 x 13.8 x 4.7 in)

8 WARRANTY

The C401/301/201/102/101 Colorimeter is supplied with a **2-year** warranty from manufacturing defects.

If repair or adjustment is necessary and has not been the result of abuse or misuse within the designated period, please return – freight pre-paid – and correction will be made without charge. Eutech Instruments/ Oakton Instruments will determine if the product problem is due to deviations or customer misuse.

Out of warranty products will be repaired on a charged basis.

Exclusions

The warranty on your instrument shall not apply to defects resulting from:

- Improper or inadequate maintenance by customer
- Unauthorized modification or misuse
- Operation outside of the environment specifications of the products

Waterproof Seal: Opening the instrument enclosure (excluding the battery compartment) may void the warranty.

9 RETURN OF ITEMS

Authorization must be obtained from our Customer Service Department or authorized distributor before returning items for any reason. A “Return Goods Authorization” (RGA) form is available through our Authorized Distributor. Please include data regarding the reason the items are to be returned. For your protection, items must be carefully packed to prevent damage in shipment and insured against possible damage or loss. Eutech Instruments/ Oakton Instruments will not be responsible for damage resulting from careless or insufficient packing. A restocking charge will be made on all unauthorized returns.

NOTE:

Eutech Instruments Pte Ltd/ Oakton Instruments reserve the right to make improvements in design, construction, and appearance of products without notice.

CLIAwaivedTM.com

Distributed by: **CLIAwaived.com™**
San Diego, CA 92121
tel 858-481-5031
toll free 888-882-7739
www.cliawaived.com

CLIAwaived.com™

For more information on Eutech Instruments/ Oakton Instruments' products, contact your nearest distributor or visit our website listed below:

<p>Oakton Instruments P.O Box 5136, Vernon Hills, IL60061, USA Tel: (1) 888-462-5866 Fax: (1) 847-247-2984 E-mail: info@4oakton.com Web-site: www.4oakton.com</p>	<p>Eutech Instruments Pte Ltd Blk 55, Ayer Rajah Crescent, #04-16/24 Singapore 139949 Tel: (65) 6778 6876 Fax: (65) 6773 0836 E-mail: marketing@eutechinst.com Web-site: www.eutechinst.com</p>	
-------------------------------------------------------------------------------------------------------------------------------------------------------------------------------------------------------------------------------------------------------------------------------------	------------------------------------------------------------------------------------------------------------------------------------------------------------------------------------------------------------------------------------------------------------------------------------------------------------------------------	--